

ES4-2071 R 4C 1274 4  
RICHARD B FONES JR  
25 BALTIMORE - ANNAPOLIS  
BLVD - FERNDALE  
GLEN BURNIE MD 21061

September, 1974 □ 75 cents

# Electronic Servicing



A HOWARD W. SAMS PUBLICATION

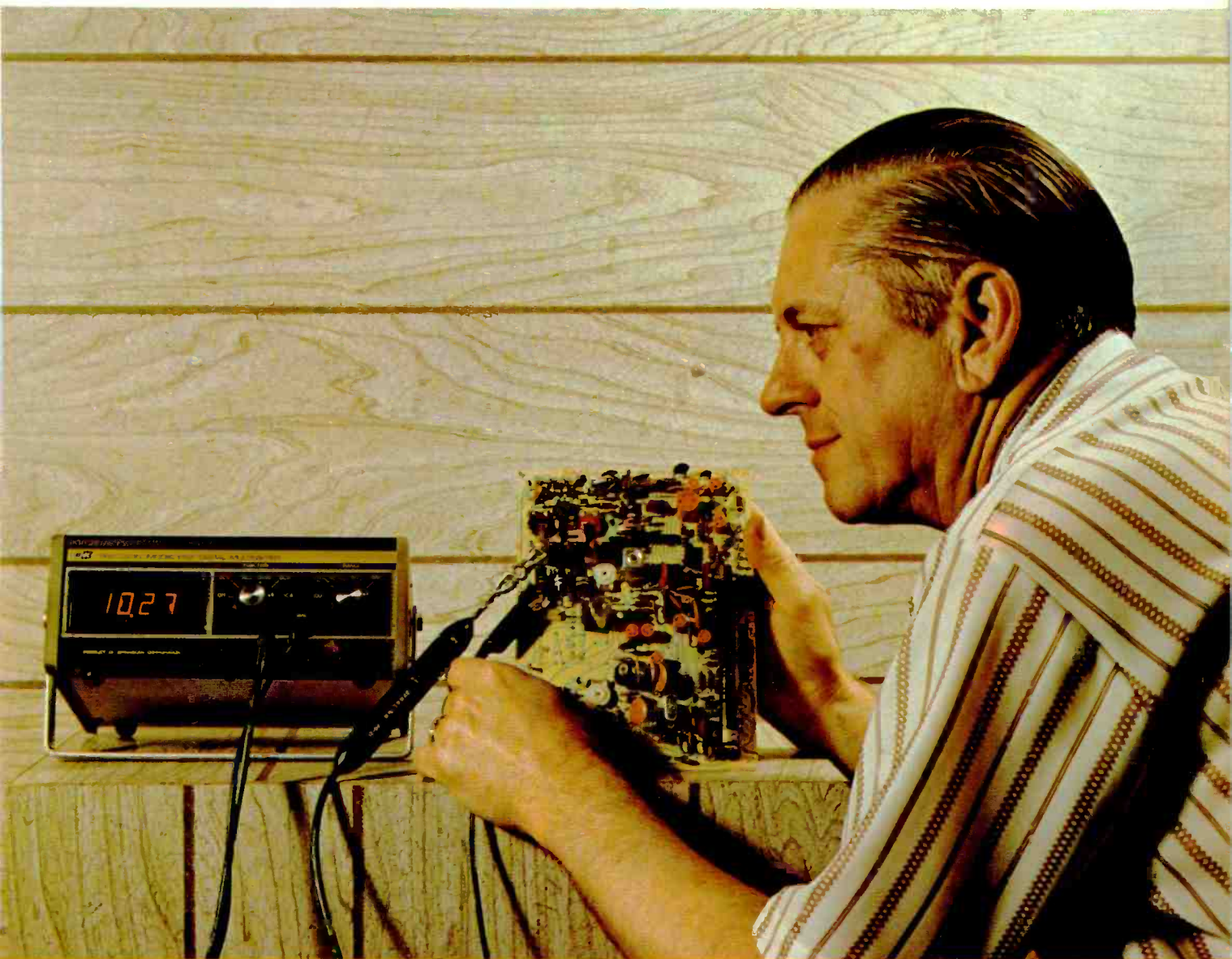

## WARRANTIES UNDER FIRE

Servicing Modules  
Motorola AGC Repairs  
Reports From Test Lab

# PTS ELECTRONICS

Precision Tuner Service



now available near you

ALABAMA: PTS ELECTRONICS 524 32ND ST. SOUTH BIRMINGHAM, ALA. 35222 TEL 205 323-2647	CALIFORNIA—NORTH: PTS ELECTRONICS 4611 AUBURN BLVD SACRAMENTO, CALIF. 95841 TEL 916 482-6270	CALIFORNIA—SOUTH: PTS ELECTRONICS 5113 UNIVERSITY AVE SAN DIEGO, CALIF. 92105 TEL 714 280-7070	COLORADO: PTS ELECTRONICS 4958 ALLISON ST ARVADA, COLO. 80001 TEL 303 423-7080	FLORIDA—NORTH: PTS ELECTRONICS 12934 N.W. 7TH AVE MIAMI, FLA. 33168 TEL 305 685-9811	FLORIDA—SOUTH: PTS ELECTRONICS 1818 BLANDING BLVD JACKSONVILLE, FLA. 32210 TEL 904 389-9952	HOME OFFICE—INDIANA: PTS ELECTRONICS 5293 S. HWY. 37 BLOOMINGTON, IND. 47401 TEL 812 824-9331	KANSAS: PTS ELECTRONICS 3116 MERIAM LANE KANSAS CITY, KANSAS 66100 TEL 913 831-1222
TEXAS—EAST: PTS ELECTRONICS 4324 26 TELEPHONE RD HOUSTON, TEX. 77032 TEL 713 644-6793							LOUISIANA: PTS ELECTRONICS 2914 WYCHWOOD DRIVE METARRIE, LOUISIANA 70033 TEL 504 885-2349
TEXAS—NORTH: PTS ELECTRONICS MOPAC LANE LONGVIEW, TEX. 75601 TEL 214 753-4334							MARYLAND: PTS ELECTRONICS 1105 SPRING ST SILVER SPRING, MD. 20910 TEL 301 565-0025
TENNESSEE: PTS ELECTRONICS 3614 LAMAR AVE MEMPHIS, TENN. 38118 TEL 901 365-1918							MASSACHUSETTS: PTS ELECTRONICS 191 CHESTNUT ST SPRINGFIELD, MASS. 01103 TEL 413 734-2737
PENNSYLVANIA—WEST: PTS ELECTRONICS 257 RIVERVIEW AVE. W PITTSBURGH, PA. 15202 TEL 412 761-7548							MICHIGAN: PTS ELECTRONICS 13709 W. EIGHT MILE RD. DETROIT, MICH. 48235 TEL 313 862-1783
PENNSYLVANIA—EAST: PTS ELECTRONICS 1921 S. 70TH ST PHILADELPHIA, PA. 19142 TEL 215 724-0999							MINNESOTA: PTS ELECTRONICS 915 W. LAKE ST MINNEAPOLIS, MINN. 55408 TEL 612 824-2333
OREGON: PTS ELECTRONICS 5220 N.E. SANDY BLVD PORTLAND, OREGON 97213 Tel 503 282-9636	OKLAHOMA: PTS ELECTRONICS 3007 N. MAY OKLAHOMA CITY, OKLA. 73106 TEL. 405 947-2913	OHIO—SOUTH: US TUNER SERVICE 8180 VINE ST CINCINNATI, OHIO 45215 TEL 513 821-2298	OHIO: PTS ELECTRONICS 5682 STATE RD. CLEVELAND, OHIO 44134 TEL 216 845-4480	NORTH CAROLINA: PTS ELECTRONICS 724 SIEGLE AVE CHARLOTTE, N.C. 28205 TEL 704 332-8007	NEW YORK CITY— NEW JERSEY: PTS ELECTRONICS 158 MARKET ST. PATERSON, N.J. 07407 TEL 201 791-6380	NEW YORK: PTS ELECTRONICS 993 SYCAMORE ST BUFFALO, N.Y. 14212 TEL 716 891-4935	MISSOURI: PTS ELECTRONICS 8456 PAGE BLVD. ST. LOUIS, MO. 63130

## LET US TAKE CARE OF YOUR TUNER PROBLEMS...

PTS will repair any tuner - no matter how old or new - black & white or color - transistor or tubes - varactor or electronically tuned - detent UHF. 8 hour service is a must!

### ...THIS IS THE SERVICE WE OFFER:

1. Fastest Service—8 hour—in and out the same day. Overnight transit to one of our strategically located plants.
2. Best Quality—Your customers are satisfied and you are not bothered with returning tuners for rework.
3. PTS uses only ORIGINAL PARTS! No homemade or make-do, inferior merchandise (this is why we charge for major parts!). You get your tuner back in ORIGINAL EQUIPMENT condition.
4. PTS is recommended by more TV Manufacturers than any other tuner company.
5. PTS is overhauling more tuners than all other tuner services combined.



Fast **8** hr. Service!

We offer you finer, faster...

...Precision  
Tuner Service



ELECTRONICS, INC....

...Number ONE and still trying harder!  
(Not a Franchise Company)

VHF, UHF	\$10.95
UV-COMBO	17.95
IF-SUBCHASSIS	12.50

Major parts and shipping charged at cost.  
(Dealer net!)

Over 4000 exact tuner replacements available for \$14.95 up (new or rebuilt).

For More Details Circle (1) on Reply Card

# No other 10 MHz oscilloscope gives you all this for \$475

The TELEQUIPMENT D61 is a low priced 10 MHz dual trace oscilloscope with sweep rates up to 100 ns/div. It is ideally suited for students, technicians, and hobbyists.

**Operating Ease.** Front panel controls are engineered for instant recognition. Line or

frame displays are selected automatically in the TV trigger position. And, chopped or alternate modes are determined automatically to optimize display clarity.

**Bright, stable viewing.** Stable waveforms, displayed on an 8 x 10 cm crt, are easy to view, even under unfavorable ambient light conditions. Two identical input channels simplify generation of X-Y displays. This is particularly useful in analysis of vector patterns.

**Application versatility.** Because of its X-Y capability, the D61 simplifies alignment and troubleshooting of color television sets. Its performance equals or exceeds the requirements for servicing audio equipment, pocket calculators, public safety control, alarm, and communications systems, microwave ovens, digital clocks, and similar consumer electronic products.

**Compact, portable.** Fully transistorized, and weighing only 15 pounds, the D61 occupies only 6.3 inches of bench width. It's easy to transport and use in confined working areas.

**Tektronix reliability.** TELEQUIPMENT products carry the well-known Tektronix warranty and are marketed and supported by the Tektronix organization.

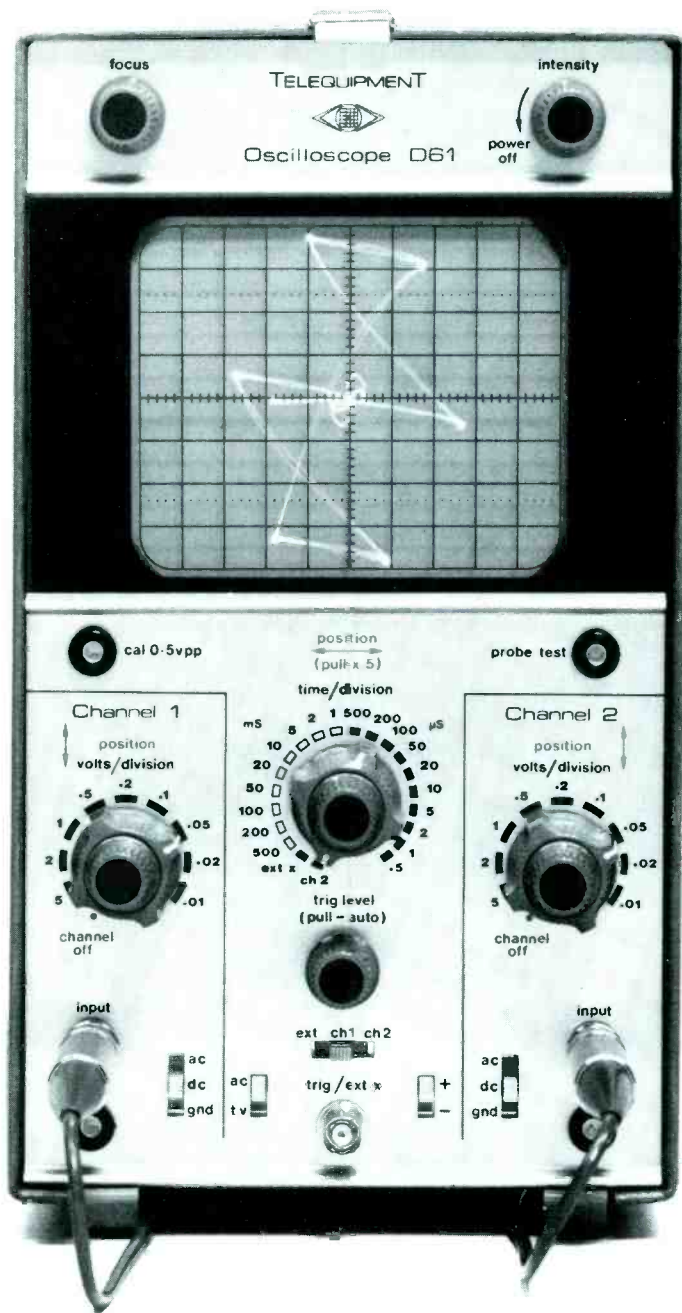

**Automatic triggering.  
TV Frame  
and line triggering.  
Dual-trace, X-Y  
and vector modes.**

- Send me the D61 Spec Sheet and Telequipment catalog.
- Have your field engineer call to arrange a demonstration.

Tektronix, Inc., P.O. Box 500, Beaverton, Oregon 97005

Name \_\_\_\_\_  
Title \_\_\_\_\_ Telephone No. \_\_\_\_\_  
Company \_\_\_\_\_  
Address \_\_\_\_\_  
City \_\_\_\_\_ State \_\_\_\_\_ Zip \_\_\_\_\_



**TEKTRONIX®**  
committed to  
technical excellence

# electronic **scanner**

news of the industry

---

**Sharp Electronics Corporation has demonstrated** a new flat electroluminescent panel which is thinner than an ordinary pane of window glass and is capable of reproducing a bright, clear TV picture. According to William Anderson, Sharp vice-president, the company has developed the technology to mass produce panel TV and is hoping to demonstrate the system in the U.S. this fall. Because of the panel's compatibility with digital circuitry, calculator display and computer use probably will be the first area of application for the panel. "Utilizing miniaturized IC's," stated Anderson in **Home Furnishings Daily**, "a 19-inch Sharp panel TV could easily fit into any standard attache case."

**A low-cost horizontal deflection system** for TV receivers designed around a silicon controlled rectifier (SCR) was demonstrated at the IEEE Spring Conference by the Solid State Division of RCA. Isolation is achieved by utilizing the flyback transformer, thus eliminating the need for a 60-Hz line transformer. According to **Radio and Television Weekly**, other features include E-W pincushion correction, "cold chassis" operation, and an SCR boost regulator that achieves regulation of all chassis power supplies against line fluctuations between 100 and 140 volts without any change in picture width.

**Women's Liberation has made an appearance** in the TV and appliance business with the arrival of Judy Eubanks and her "Home Makers Appliance Center" at 11221 Manchester Road in South St. Louis County, Missouri. "A new concept of selling TV and appliances, the store is owned and operated by women, who are well trained," stated Miss Eubanks in **Radio and Television Weekly**.

**Replacement of the vast and growing reservoir** of aging color television sets in consumer homes is expected to be an increasingly important factor in sales of the product. Sources within the color TV industry feel the inclination of consumers to buy a new set rather than repair an old one will increase because of the heavier costs involved in servicing the all solid-state models which are steadily becoming a bigger portion of total industry sales. According to **Home Furnishings Daily**, the replacement cost of a new set has been declining; in 1969, the average factory price of a color TV set was \$328, while the estimated figure for 1974 is \$312.

**The proposed all-channel radio receiver law**, already approved by the Senate, was supported by the National Appliance and Radio-TV Dealers Association and the Federal Communications Commission, but again opposed by the Consumer Electronics Group of the Electronics Industries Association. The law would give the FCC discretionary power to require all radios retailing for more than \$15 to be AM/FM types; the FCC said it first would use such power for car radios, before it ever took a look at the home radio market, reports **Home Furnishings Daily**.

(Continued on page 6)

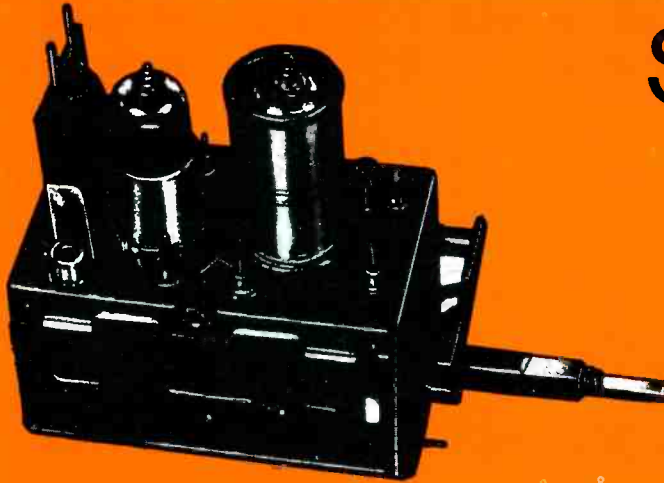

**STILL ONLY**  
**\$9.95**  
 ALL PARTS INCLUDED  
 EXCEPT TUBES & TRANSISTORS

ONE YEAR GUARANTEE

# TUNER SERVICE CORPORATION

PROVIDES YOU WITH A COMPLETE SERVICE FOR ALL YOUR TELEVISION TUNER REQUIREMENTS.

## REPLACE

Universal Replacement Tuner **\$12.95** (In Canada \$15.95)

This price buys you a complete new tuner built specifically by **SARKES TARZIAN INC.** for this purpose.

All shafts have a maximum length of 10½" which can be cut to 1½".

Specify heater type parallel and series 450mA or 600mA.

## REPAIR

VHF Or UHF Any Type **\$9.95.**  
 UHF/VHF Combo **\$15.00.**

In this price all parts are included, tubes, transistors, diodes, and nuvistors are charged extra. This price does not cover mutilated tuners.

Fast efficient service at our conveniently located service centers.

All tuners ultrasonically cleaned, repaired, realigned and air tested.

## CUSTOMIZE

Customized tuners are available at a cost of only **\$15.95**; (with trade-in **\$13.95**) (In Canada \$17.95/\$15.95)

Send in your original tuner for comparison purposes.



HEADQUARTERS	BLOOMINGTON, INDIANA 47401	537 S. Walnut Street	Tel. 812-334-0411
ARIZONA	TUCSON, ARIZONA 85713	1528 So. 6th Street, P.O. Box 4534	Tel. 602-791-9243
CALIFORNIA	NORTH HOLLYWOOD, CALIF. 91601	10654 Magnolia Boulevard	Tel. 213-769-2720
	BURLINGAME, CALIF. 94010	1324 Marsten Road	Tel. 415-347-5728
	MODESTO, CALIF. 95351	123 Phoenix Avenue	Tel. 209-521-8051
FLORIDA	TAMPA, FLORIDA 33606	1505 Cypress Street	Tel. 813-253-0324
GEORGIA	ATLANTA, GEORGIA 30310	938 Gordon Street S.W.	Tel. 404-758-2232
ILLINOIS	CHAMPAIGN, ILLINOIS 61820	405 East University Street	Tel. 217-356-6400
	CHICAGO, ILLINOIS 60621	737 West 55th Street	Tel. 312-873-5556-7
	SKOKIE, ILLINOIS 60076	5110 West Brown Street	Tel. 312-675-0230
INDIANA	HAMMOND, INDIANA 46323	6833 Grand Avenue	Tel. 219-845-2676
	INDIANAPOLIS, INDIANA 46204	112 W. St. Clair St.	Tel. 317-632-3493
KENTUCKY	LOUISVILLE, KENTUCKY 40208	2920 Taylor Boulevard	Tel. 502-634-3334
LOUISIANA	SHREVEPORT, LOUISIANA 71104	3025 Highland Ave.	Tel. 318-861-7745
MARYLAND	BALTIMORE, MD. 21215	5505 Reisterstown Rd., P.O. Box 2624	Tel. 301-358-1186
MISSOURI	ST. LOUIS, MISSOURI 63132	10530 Page Avenue	Tel. 314-429-0633
NEVADA	LAS VEGAS, NEVADA 89102	1412 Western Ave. No. 1	Tel. 702-384-4235
NEW JERSEY	JERSEY CITY, NEW JERSEY 07307	547-49 Tonnesle Avenue HWY 1&9	Tel. 201-792-3730
	TRENTON, NEW JERSEY 08638	901 N. Olden Ave.	Tel. 609-393-0999
OHIO	CINCINNATI, OHIO 45216	7450 Vine Street	Tel. 513-821-5080
	CLEVELAND, OHIO 44109	4597 Pearl Road	Tel. 216-741-2314
OREGON	PORTLAND, OREGON 97210	1732 N.W. 25th Avenue	Tel. 503-222-9059
TENNESSEE	GREENEVILLE, TENNESSEE 37743	1215 Snappa Ferry Road	Tel. 615-639-8451
	MEMPHIS, TENNESSEE 38111	3158 Barron Ave.	Tel. 901-458-2355
TEXAS	DALLAS, TEXAS 75218	11540 Garland Road	Tel. 214-327-8413
VIRGINIA	NORFOLK, VIRGINIA 23513	3295 Santos Street	Tel. 703-855-2518
CANADA	ST. LAURENT, MONTREAL, QUEBEC H4N-2L7	305 Decarie Blvd.	Tel. 514-748-8803

WATCH US GROW

IF YOU WANT TO BRANCH OUT INTO TV TUNER REPAIR BUSINESS, WRITE TO TSC HEADQUARTERS ABOUT A FRANCHISE

For More Details Circle (6) on Reply Card

A unique air traffic-control subsystem utilizing a gas discharge or plasma panel display has been delivered to the Federal Aviation Administration by Aerospace/Optical Division of International Telephone and Telegraph Corporation. A plasma panel display has two plates of glass sealed at the edges forming an envelope filled with neon gas. The glass plates each have 512 lines of gold wire etched and plated on them and positioned at right angles to each other. This orthogonal matrix of 262,144 discrete points can be addressed selectively by the computer and when the proper voltages are applied, these points glow like a neon lamp.

The Federal Trade Commission approved the plan of the National Electronics Service Dealers Association (NESDA) to offer lower repair rates to consumers who purchase appliances from them. NESDA members would issue a coupon discount book that would entitle the consumer to a discount off regular repair rates. NESDA feels this will give the dealer a selling point; he will repair the product sold by him at a cheaper price since he made a profit on the original sale, according to **Home Furnishings Daily**.

Jules Steinberg of NARDA, Dick Glass, executive vice-president of NESDA, and Frank Moch, director of NATESA, believe that the first step towards a healthy recovery of the TV service industry is for service dealers to charge realistic service rates. The three officials also stated that dealers must demand reasonable reimbursement rates from manufacturers for in-warranty service. Three problem areas for the service dealer include the high cost of parts inventory, the increase of solid-state products which require fewer repairs, and a consumer shift to low-end merchandise. As reported in **Home Furnishings Daily**, Steinberg offered the following labor rate tips for service dealers: offering more service contracts, servicing different products other than white and brown goods, employing assembly-line service, and hiring capable technicians.

Collins Radio group of Rockwell International Corporation has received a contract to provide earth-station ground-communication equipment (GCE) for AT&T's Domestic Satellite Communications (DOMSAT) program. The new station will be owned and operated by AT&T and will be placed in service between September and December 1975, using satellites to be launched and maintained for AT&T by COMSAT General Corporation. The system will utilize dual polarization to allow placing 24 transponders in each satellite; each transponder will have an effective bandwidth of 36 MHz and the GCE equipment has been designed for 1200 voice channels per transponder.

Chuck Simms, the president of the Action TV Rental chain based in Houston, is convinced that brown goods rental, rather than retailing, is the way to go; he has tripled the size of his operation in one move. Typical rental charges are \$12 per week or \$39 per month for an 18-inch color portable and \$15 per week for a 25-inch color console; charges vary with set features, length of rental time and intention to buy. Simms figures the average useful life of a rental TV set is around 18 months, and about one out of 10 customers rents to buy at the end of that period, reports **Home Furnishings Daily**. □

# while the guy down the street complains about how tough alignments are...I do them!

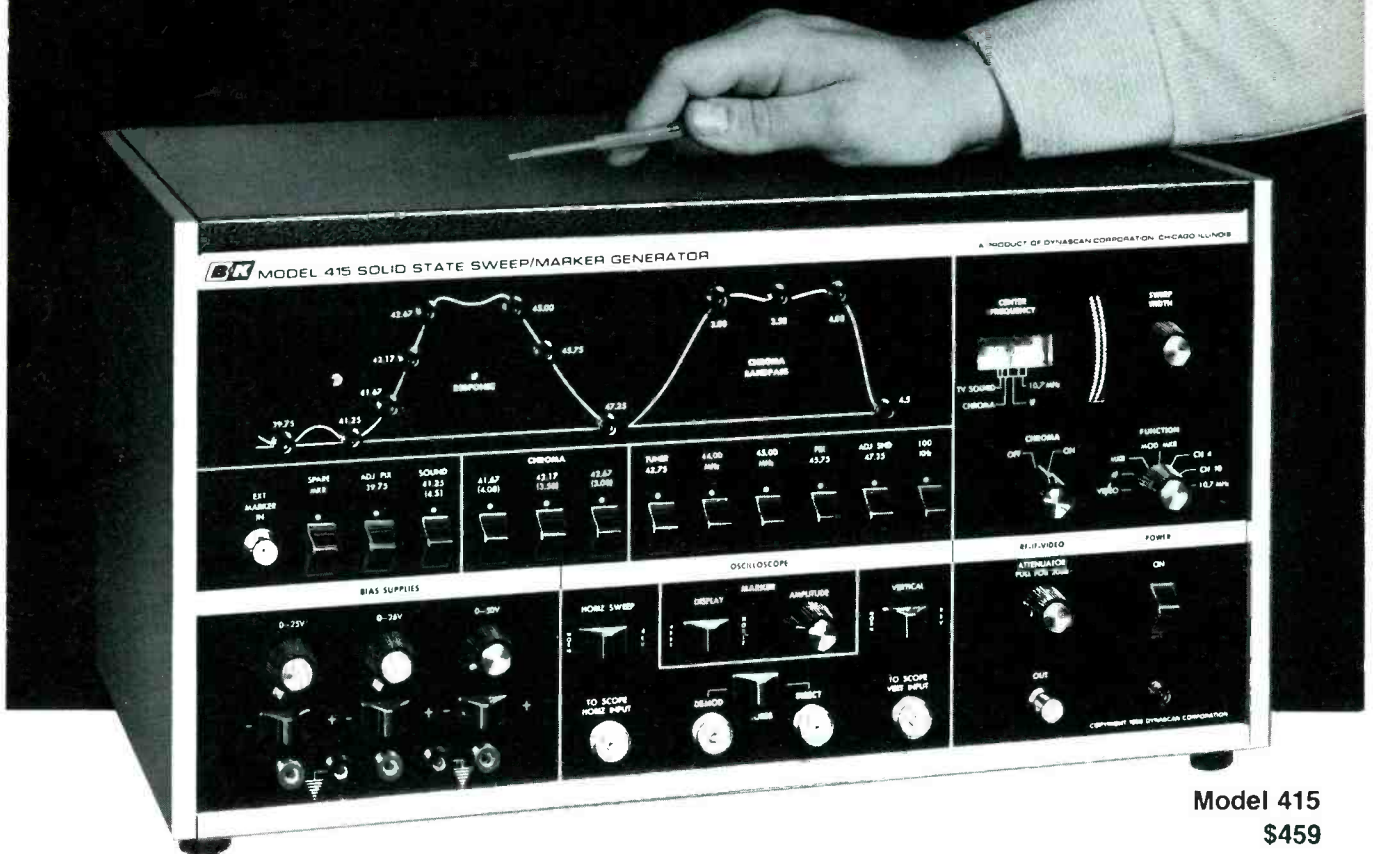

**Model 415**  
**\$459**

I used to hook up a separate sweep generator, marker generator, marker adder and bias supply, hope that everything was properly calibrated and adjusted, and pray that the alignment would hold after I disconnected the cables draped all over the bench.

I didn't do it very often.

Now, in the time it used to take me just to set up, I can almost complete an alignment. And I'm confident the set will perform as well as it possibly can. My customers notice, too. That's the difference B&K's 415 Solid-State Sweep/Marker Generator made.

Setup is no problem. After I connect the 415's outputs to my scope (there's even low-frequency compensation to eliminate pattern errors), I connect its RF outputs (channel 4 or 10) to the antenna terminals or mixer test point, the direct probe to the video detector test point (or anywhere else after the video detector diode) and the demodulator probe to the bandpass amplifier output.

They're all clip-on connections, and the 415 comes with all the accessories I need. Once I've made the initial signal and bias hookups, there's nothing else to connect or reconnect. All interconnecting changes and generator functions are controlled from the front panel. There's even a 15,750Hz filter to eliminate disabling

the set's horizontal output section.

Shaping the waveform is easy, because the 415 has 10 crystal-controlled IF markers, each of which lights up on the front-panel waveform diagram as it is used. Markers can be shown either vertically or horizontally on the scope trace. There's a 100kHz modulated marker that makes nulling the traps so easy it's almost automatic. And three low-impedance, reversible-polarity bias supplies—two, 0-25VDC; one, 0-50VDC.

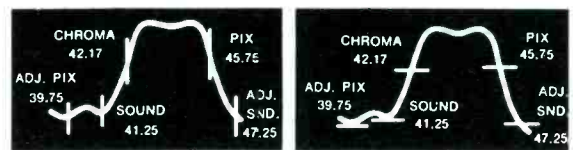

Vertical Markers

Markers Tilted Horizontally

Every step is easy to understand, too, thanks to the comprehensive manual.

Since I have nothing to sell but my time, I have to make the most profitable use of it I can. That's why I have a B&K 415.

*In stock now at your local distributor or write Dynascan.*

**B&K** PRODUCTS OF  
**DYNASCAN**

1801 W. Belle Plaine Ave. • Chicago, IL 60613 • Phone (312) 327-7270

Complete Line of Analog and Digital Multimeters, Oscilloscopes, Signal Generators, Semiconductor Testers, Power Supplies, Probes, Tube Testers and Substitution Boxes.

Chassis—Motorola TS-929, TS-934  
PHOTOFACT—1398-2

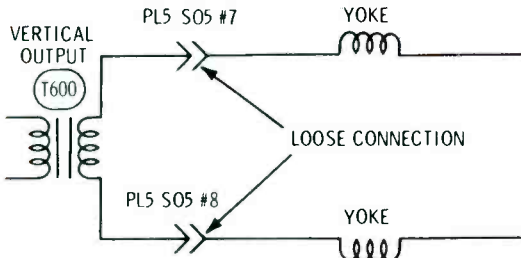

**Symptom**—Slight compression at top and bottom of picture  
**Cure**—Check pins of yoke socket; tighten if loose

Chassis—Motorola TS-929, TS-934  
PHOTOFACT—1398-2

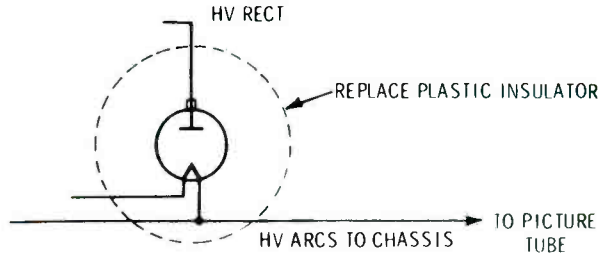

**Symptom**—Loud arcing  
**Cure**—If early model with tube HV rectifier, replace the HV insulator

Chassis—Motorola TS-929, TS-934  
PHOTOFACT—1398-2

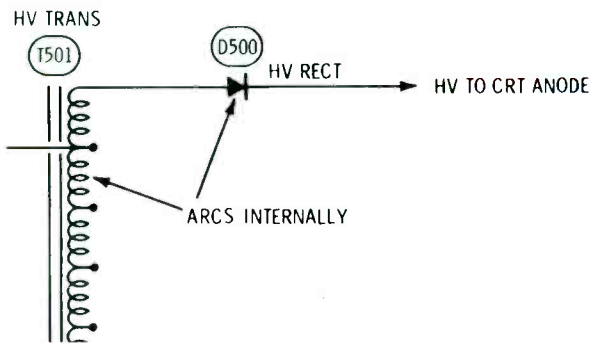

**Symptom**—Vertical bar of noise on left side of picture  
**Cure**—Replace the diode HV rectifier; if that doesn't help, replace the HV transformer

Chassis—Motorola TS-929, TS-934  
PHOTOFACT—1398-2

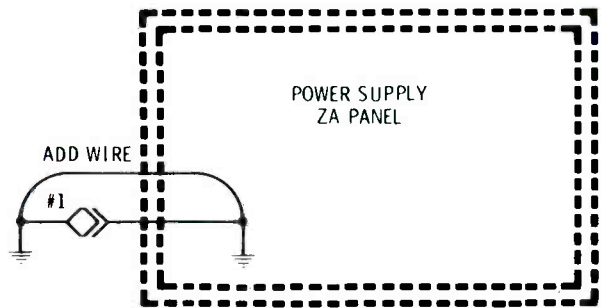

**Symptom**—Hum bars in picture  
**Cure**—Check #1 pin connection of ZA power panel. Tighten, or add a jumper wire from chassis to panel ground foil

Chassis—Motorola TS-929, TS-934  
PHOTOFACT—1398-2

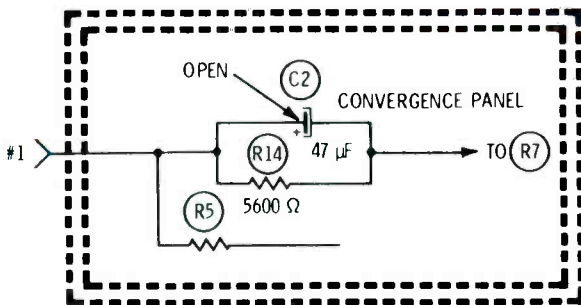

**Symptom**—Picture stretched at top and compressed at bottom  
**Cure**—Check C2 on the HA convergence panel; replace it if open

Chassis—Motorola TS-915, TS-919  
PHOTOFACT—953-1

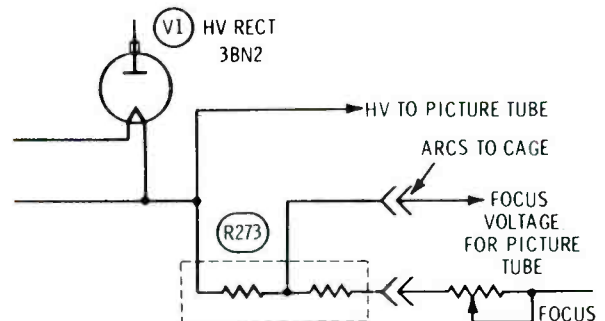

**Symptom**—Intermittent focus, or loss of brightness  
**Cure**—Check for arc between focus plug and cage



## reader's exchange

**Needed:** Updated roll chart for a Jackson Electrical Instrument Company model 648 tube tester.

Norman Braun  
411 South Jefferson Street  
St. Ansgar, Iowa 50472

**Needed:** XXD or 14AF7 tube for Philco radio.

Gibson Radio and TV Service  
110 Clark Avenue  
Punxsutawney, Pennsylvania 15767

**Needed:** Schematic for Eric model 225 stereo receiver (Palomino).

L. R. Richey  
2652 Colby Avenue  
Los Angeles, California 90064

**Needed:** Operating manual, schematic and parts list for a Webster Chicago model RMA-375 wire recorder. Will buy, or copy and return.

Raymond Friend  
236 West Pearl Street  
Butler, Pennsylvania 16001

**Needed:** Instruction book, schematic and possible parts for a late model US Navy radio receiving set AN/SRR-13A, utilizing a radio receiver type R/441-A/SRR-13A.

John R. Eickhof  
P.O. Box 127  
Kings Beach, California 95719

**Needed:** Instruction book and schematic for a Stereoscope model 556 scope, which was manufactured by Scope Electronics.

Sal W. Ferraro  
560 Midland Avenue  
Garfield, New Jersey 07026

**Needed:** Schematic and manual for Paco oscilloscope model S-55.

John M. Craddock  
Box 151  
Gibsonville, North Carolina 27249

**Needed:** Schematic for Allen Electronic Corporation model 251 power supply for an organ.

Edward C. Brown  
Box 134  
Cromberg, California 96103

**Needed:** Schematic or any available information on Progress-Webster soundguard transistor intercom model SG-8407.

W. Holcombe  
The TV Man, Inc.  
4941 Harford Avenue  
Beltsville, Maryland 20705

# DO-IT-YOURSELF grabber

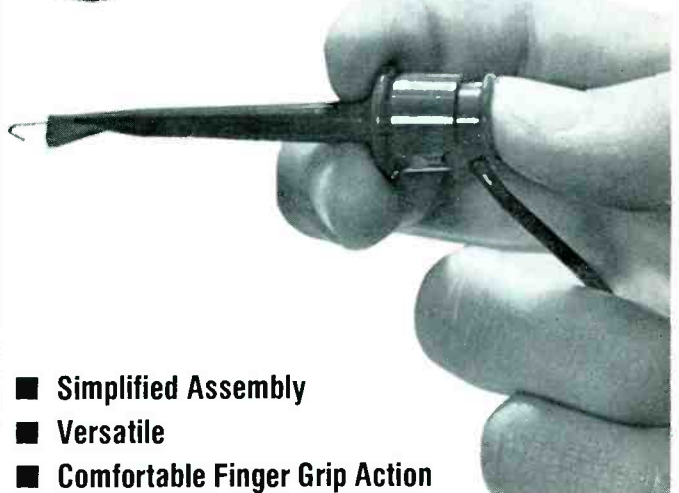

- Simplified Assembly
- Versatile
- Comfortable Finger Grip Action
- Completely Field Serviceable
- Molded of Tough Lexan\*

Model 3925  
Mini Test Clip  
Shown Actual Size

This test clip with gold plated hook is excellent for rapid testing of components and Wire Wrap† pins. Clip is completely insulated to point of connection. Build any combination of test leads with wire up to .090 dia. Easy and comfortable to operate. Molded of rugged Lexan to resist melting when soldering. Write for literature and prices.

### SIMPLIFIED ASSEMBLY



Rapid assembly or replacement  
of damaged lead.

### MODEL 3925

hooks onto components or slips over square Wire-Wrap pins

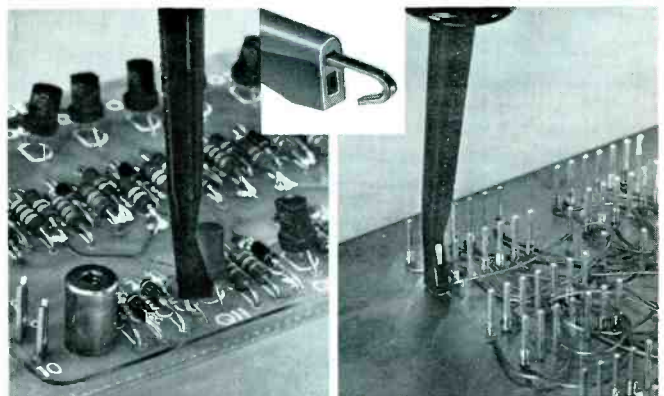

\*Lexan is a General Electric trade-mark. †Registered trade-mark of Gardner-Denver Co.

AVAILABLE ONLY THROUGH ELECTRONIC PARTS DISTRIBUTORS



**POMONA ELECTRONICS**

A Subsidiary of ITT

1500 East Ninth St., Pomona, Calif. 91766

For More Details Circle (8) on Reply Card

# FAST

**COMPLETE SERVICE ON ALL MAKES OF TV TUNERS**

Maximum Time In Shop 24 Hrs.

(Warranty: One Full Year)

(WE SHIP C.O.D.)  
YOU PAY SHIPPING  
**\$9.95**

Black & White  
or Color

VHF or UHF



UV Combo's \$16.50

Price includes all labor and parts except Tubes, Diodes & Transistors. If combo tuner needs only one unit repaired, disassemble and ship only defective unit. Otherwise there will be a charge for a combo tuner. When sending tuners for repair, remove mounting brackets, knobs, indicator dials, remote fine tuning arrangements and remote control drive units.

**WE UNCONDITIONALLY GUARANTEE All Tuners FOR ONE FULL YEAR**



All tuners are serviced by EXPERTLY TRAINED TECHNICIANS with years of experience in this specialized field. All tuners are ALIGNED TO MANUFACTURER'S SPECIFICATION on crystal controlled equipment and air checked on monitor before shipping to assure that tuner is operating properly.

**GEM CITY TUNER SERVICE**

Box 6G Dabel Station  
1621 Mardon Drive  
Dayton, Ohio 45420

# troubleshootingtips

Send in your helpful tips—we pay!

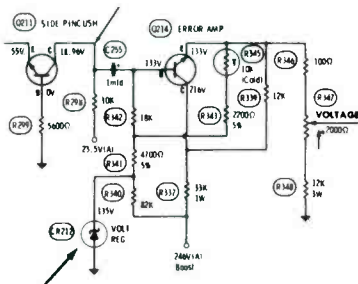

## Intermittent brightness Zenith 25DC57 color chassis (Photofact 1315-3)

According to the customer, the set would play for several hours and then lose brightness, but the sound was okay.

When the trouble occurred on the test bench, there was no drive to the base of the horizontal-output transistor. Unfortunately, a new horizontal module did not help.

Voltage tests on the module showed 24 volts at B12 (normal), 96 volts at U10 (high), the 125-volt source was 140 volts, and only a few tenths of a volt at T7, the oscillator collector (low).

At this point, I chose the wrong course (as many technicians might) by checking the **low** voltage instead of the **high** one. In transistor circuits, high voltages are just as troublesome as low ones.

I checked the limit-switch circuit and found it to be the cause of the low oscillator voltage. Excessive HV pulses because of the abnormal 125-volt source voltage were the cause.

Even though I was now on target, the trouble was hard to find. Voltages at the anode of CR212 and the collectors of Q213 and Q215 were normal, but the biases were all wrong and adjustment of the Voltage control didn't help. With either Q213 or Q214 removed, the brightness came back, but the supply was only +110 volts.

Finally, I decided to defeat the limit-switch action. Now the voltages were about the same as before, except for the anode of CR212,

which now checked +250. No, the diode was not open, but **there was a poor solder joint where the cathode was grounded.**

Here is the chain of events: with CR212 open, the 125-volt supply was high, producing excessive HV pulses which activated the limit circuit to shut down the horizontal sweep; without the sweep, there was no boost voltage; without boost voltage, the voltage of CR212 was not excessive, which obscured the fact that it was open. Only by temporary restoration of the high voltage could there be boost voltage and a wrong voltage on CR212.

Many times it's a good technique to defeat any circuits designed to throw the vertical or horizontal out of frequency, or ones like this that kill the horizontal sweep. Usually there is no danger of damage to the receiver, if you don't operate it too long with the protective circuit defeated, and only then can you obtain valid tests.

Gary Steenwyk  
Holland, Michigan

## Weak horizontal locking Admiral G13 color chassis (Photofact 844-1)

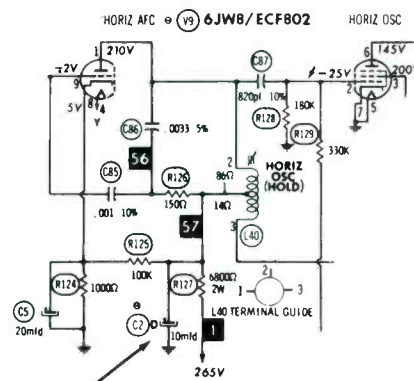

Horizontal locking was very critical, and the picture often would float either right or left.

These symptoms pointed to the horizontal AFC stage, because the vertical locking was normal. An oscillator defect was not likely because the frequency was correct.

Waveforms at the AFC diode were okay, but resistance tests showed a slight mismatch of forward/reverse resistances of X8 duodiode. I replaced X8 and the 47 pF sync-coupling capacitor, but there was no difference. All other capacitors in the AFC circuit were tested, but all were normal.

Finally, after much wasted time, I found a 200 volt p-p signal at the plate of the AFC tube instead of the normal 50 to 60 volts. Also, a high-amplitude waveform was found at pin 1 of L40, the horizontal oscillator coil. This point should have almost no AC signal because it is bypassed by C2D. Yes, **C2D was open**, and a new one restored normal operation.

James E. Crockett  
Huntingdon, Tennessee

**No HV, or horizontal tearing  
Panasonic b-w chassis**  
(Photofact 1017-2)

Symptoms of no HV, slow warm-up of HV, or a slight tearing effect (often intermittent) can be caused by C68, a 6800 pF Styrol-type capacitor in the oscillator circuit.

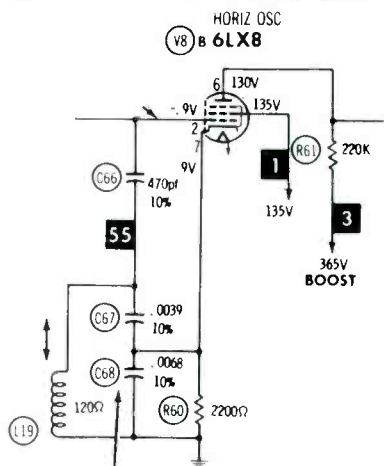

I maintain about 350 of these sets and have had perhaps 30 with this capacitor defective.

A Mallory type SX268 or SX262 makes an excellent replacement. Sometimes the defect will cause the line fuse to open, and because the trouble is intermittent, the set might operate fine after the fuse is replaced. Better replace the capacitor to prevent call-backs.

John McKeough  
Buffalo, New York

# ARE YOUR KIDS WATCHING OFF-COLOR TV?



## THEN CALL YOUR NEIGHBORHOOD TV TECHNICIAN.

When Marshal Dillon's horse starts turning green on your color TV set, don't wait until you've got really big headaches. Early attention prevents related problems and makes it easier... and less expensive... to find and cure the trouble. Call your independent TV-radio service technician when color trouble starts.

**THIS MESSAGE WAS PREPARED BY SPRAGUE PRODUCTS COMPANY,**  
DISTRIBUTORS' SUPPLY SUBSIDIARY OF SPRAGUE ELECTRIC COMPANY, NORTH ADAMS, MASSACHUSETTS FOR  
**YOUR INDEPENDENT TV-RADIO SERVICE DEALER**

# PUT THIS BUSINESS-BUILDING TRAFFIC-STOPPER ON YOUR SHOP WALL OR IN YOUR WINDOW

See your Sprague Distributor for window-size blow-ups of this message. Or, send 25¢ to Sprague Products Co., 105 Marshall St., North Adams, Mass. 01247 to cover handling and mailing costs. Just ask for Poster RP-41.



THE BROAD-LINE PRODUCER OF ELECTRONIC PARTS

For More Details Circle (9) on Reply Card

# Warranty discussion roundup

Many people who are in the business of servicing home-electronic products believe one of their most serious problems is with the warranties of the manufacturers. They contend the pay scale is so low, in many cases, that service often is performed at a loss. Also, no provision is made for the expenses of handling warranty parts.

Independent servicers complain bitterly about the channeling of warranty fulfillment to so-called "factory" branches, which prevents them from competing for the business.

Compounding these problems is the extended warranty time period which either forces them to wait

an excessive amount of time for a chance at the business (if they are not authorized), or denies them a full profit on either labor or parts for an unreasonably-long warranty period.

Next month, we hope to present other views, perhaps from the manufacturers.

The following condensed short articles are presented in the sincere hope that the comments and discussions about them will help make solutions possible.

The views expressed are not necessarily those of the editors or management of **Electronic Servicing**.

## WARRANTY—Or Sacrifice?

By James S. Ballard,  
President of Serv-A-Set, Inc.  
984 West El Camino  
Sunnyvale, California 94087

Recently, my company, Serv-A-Set, Incorporated, was asked by a large department store to do all the service work on its home-electronic products. Because our company was not already a warranty station for some of the brands they carried, it was necessary for us to apply for authorization from several manufacturers. The information we received was appalling.

Many of the labor rates for warranty service were far below our prices, and also that of other shops in our vicinity. It was probably no coincidence that three-fourths of the brands with low warranty rates were foreign imports.

This reminded me that a number of shops in our area had gone bankrupt after they became warranty stations for imports. The thought didn't bother me until I noticed the department store wanted us to service some of these same brands.

If we didn't service **all** the brands of the department store, Serv-A-Set would lose the large service contract. I wanted the revenue this

contract would bring, but I certainly wanted to avoid bankruptcy.

### The Cost Survey

Before deciding about the contract, I had to know our operating costs. So, we spent several thousand dollars with a Certified Public Accountant to obtain accurate figures. An analysis of the cost survey convinced me **not** to sign the contract.

Here are some of our net costs:

- the cost of "ringing a doorbell" within a 15-mile radius was \$17.56, assuming 8 calls per day with a 70% completion rate;
- average processing time was 2.9 hours. This starts when the call is received, includes a house call, bringing the set to the shop, repairing it, rerouting it, returning it, and posting the invoice on the books; and
- the average shop rate was \$28 per hour (including 10% profit), based on 4.5 production hours per employee. The remaining 3.5 hours in an 8-hour day was unbillable time, and included finding schematics, ordering parts, answering the telephone, sick leave and vacations.

Compare these **net** costs with the

prices offered by one manufacturer: \$17 for service call, pickup and delivery (if necessary), and shop labor (if necessary). If we assume a day of 8 calls, the income would be \$136. However, our **cost** without profit would be \$140.48, a **loss** of \$4.48! Contrast this with our regular price of \$21.95 for each service call, which would have brought in \$175.60. There's a difference of \$39.60 between warranty and our normal charges. But that's not the worst of it.

Suppose 3 of these 8 sets had to come to the shop. Our total net cost would be \$389.42, and our normal retail prices would be \$452.20, yet we actually would receive only \$136.00!

### Find Out Your Costs

Undoubtedly, your costs are different from ours; there are no reasons why they should be the same. But it is imperative that you **know** those costs. Everyone—retail dealers, consumers, and manufacturers alike—should be made aware of the range of costs of doing service today. Education (not price fixing) is the way to gain recognition of these truths. Why should a dealer sign a contract that

has all the advantages of a suicide pact?

### Price Discrimination

Service companies accepting contracts with low labor rates often are forced to engage in price discrimination (charging different prices to different manufacturers for the same type of service), if they are to survive. And they are lucky that a few manufacturers, by paying realistic labor rates, give them a chance to discriminate. If such service firms ever lose the accounts that pay the going rate, they'll quickly find out how vulnerable they are to bankruptcy.

### Damages From Underpricing

The damaging effects of performing service at a loss are not limited to that one dealer. Other dealers, the entire service industry, manufacturers that pay the going rate, and consumers also are affected.

The service industry as a whole is hurt because this type of dealer never will be able to offer retirement plans, hospitalization programs, or profit sharing that are needed to make the industry attractive to young men, and more attentive to the needs of older men. How many retired technicians have you known?

### A Declaration Of Competence

Now is the time for a declaration of competence! Independent service dealers are capable of running their own shops, and no longer should suffer the indignation of being dictated to by manufacturers. The manufacturers have a profit margin. Why shouldn't servicers also have a profit margin?

Some manufacturers might want us to think we should feel honored to serve them at any price. We mustn't be fooled. Providing service should not mean being subservient. As contractual partners, both the service agency and the manufacturer should have mutual respect and profit in a dignified relationship.

### Other Problems

So far, I have mentioned only the problem of low rates for warranty labor. But there are three other subjects of concern. These problem areas are:

- delays in receiving payment from some manufacturers;
- losses on the handling of warranty parts; and
- inequality of in-warranty versus out-of-warranty charges.

Payments for warranty labor should be made as rapidly as possible; at least once a month. Prompt service does much to restore the customer's confidence in the product. How can a dealer do this if he doesn't receive prompt payment?

At present, manufacturers make no allowances for costs involved in stocking or exchanging parts, for personal property tax, or for shipping and handling charges. In our business, these expenses average respectively 15%, 11% and 10% of the retail price of each part.

In Minnesota, the warranty law requires manufacturers to pay the dealer a 10% "profit" on warranty parts. That's not enough, but it is a step in the right direction. However, it is not a profit; it's compensation for one of the costs of doing business.

Manufacturers invite fraudulent claims when they offer inadequate payment for labor, and none for the handling of warranty parts.

It is not unusual for an out-of-warranty customer to pay up to four times as much as a manufacturer does for the same in-warranty service. Perhaps such a wide variance happens because the shop is forced to increase prices of customer service to compensate for losses from warranty business. If so, that's a very unfair thing, and the manufacturers must bear the primary blame.

Most independent servicers see the extended warranties as harmful to the manufacturers because of the greater cost (some perhaps then try to compensate by paying low prices). The servicer loses because he has no chance of a full profit on either labor or parts until the warranty has expired. And there is a strong possibility that the customer is short-changed by poorer service because of the substandard labor prices paid by the manufacturers.

Consequently, many servicers believe a 90-day labor warranty and 1 year on all parts is sufficient to protect the customer, and yet

correct some of the undesirable effects of warranties that are too long.

### It's Illegal To Sell At A Loss

The Unfair Trade Act of California makes it illegal to sell any article or product at less than cost for the purpose of injuring competitors. Many independent service firms in California are pooling their money to finance a court test of this law as it relates to service pricing. One possibility is that one service dealer might sue another who has signed a contract for below-cost service. However, if the court decision is favorable, the manufacturer who offers the below-cost contracts will be the main target.

### Summary

Some manufacturers in the past have contended that they are entitled to pay less for warranty service because of the increased volume, and because warranty customers become pay customers after expiration of the warranty. Both of these assumptions easily can be proven wrong. There is no valid reason for manufacturers to expect service at less-than-cost. I hope to convince other service dealers to stop signing contracts which change warranty service into a financial sacrifice. □

---

## Dangers From Unwise Warranty Terms

By Frank Moch,  
Executive Director of NATESA

In this era of enlightened consumerism, we recommend that the manufacturers and distributors of home electronic products face up to the long-term consequences of some of their warranty policies.

Some manufacturers seem to feel their warranty is perfectly fulfilled by purchase of service work at less-than-cost prices. We disagree. Warranties imply that service will be performed by capable craftsmen. But to furnish service without loss at the prices established by many

manufacturers, a shop could afford to pay technicians no more than \$2 to \$3 per hour. How many competent techs would work for that, when glass installers, for example, are paid more than \$9 per hour? It follows that if the technician is incompetent, then the retail customer is short-changed.

A shop that does considerable warranty work at a loss, therefore, has three alternatives: (1) go out of business; (2) overcharge the out-of-warranty customers to make up the losses; or (3) cheat on the warranty claims.

Good service shops are too rare and valuable for them to be forced into bankruptcy just to satisfy the desires of some manufacturers to hold down the cost of warranty claims. In one extreme example, a warranty station owner (who was protesting the inadequate rates) was told to "take it or leave it", "cut your servicer's wages", and "we can find others who will accept our deal."

It's certainly not fair or business-like to make up warranty losses by overcharging non-warranty customers.

And it's neither smart nor honest to pad warranty claims.

Historically, the profit from the sale of components has been an important item of income for service shops. Extended warranty terms strip away this source of profit, but do not eliminate the expenses of obtaining, stocking, or returning the defective parts to the factory. This is a double blow; the expenses stay the same, but the income is gone.

Exact reporting of the defect and its location is one part of the red tape of warranty that causes extra expense for the shops. Theoretically, this information is vital to quality control at the factory to help in spotting recurrent failures, so modifications can be made during later production runs. Unfortunately, excessive demands and losses from unallowed claims tempt underpaid and overworked technicians to make the warranty tags a work of fiction. When this happens, the feedback from field-to-factory is destroyed, and everyone loses.

The warranty race is carrying the time period to ridiculous lengths. Studies reveal that TV receivers are

used an average of 500 hours or more in 90 days, and this time should be adequate to uncover any inherent problems. Only merchandise of questionable quality needs longer warranties. By way of comparison, an automobile driven 55 miles-per-hour for 500 hours would travel 27,500 miles. How many car warranties cover even half that much usage?

Ethical professional servicers now refuse to cheat their employees, their customers, or their families by continuing to accept below-cost warranty offers. At the same time, they refuse to be deprived of the right to compete.

To help straighten out this tangled web, NATESA suggests that:

- all manufacturers pay the "going" rate for warranty service;
- a markup of 40% be allowed on all warranty components;
- the warranty period be cut back to no more than 90 days on labor and one year on parts; and
- the manufacturers scrupulously weed out double-billers and other cheaters, after adequate compensation schedules have been instituted. □

## WARRANTIES. . .The Credibility Gap

By Ed Terrien

Television Service Center

This is written not to you who now are performing warranty service for manufacturers (for you know the problems), but to you who are contemplating doing warranty work, so you will be aware of the problems.

### Warranty Has Changed

Remember when the selling dealer was responsible for service, and we service dealers contracted for it on a flat-rate basis covering a period of 90 days?

Then the manufacturers initiated in-board service, paying us a flat rate for the warranty period. If the picture on the TV only flickered, we would rush to the home, pat the customer's hand, and say "Of course there is no charge, you have a warranty." Even if the first call was a "set-up", we naively went

ahead with the adjustments believing that it was our responsibility and duty to complete the sale for the dealer and manufacturer by improving the picture. Why, we were even under the delusion that customer education was our responsibility!

Now the manufacturers pay on a per-call basis. Great! We get paid our regular rates whenever we perform service on in-warranty items. But what are all of these rejected invoices we receive with such notations as "set-ups not covered", "call-back", "model not covered under warranty program", etc. Let's discuss some of the reasons for such rejects.

### Set-ups

If it is necessary to go inside the set and adjust the AGC, high voltage, convergence or purity, be sure of the manufacturer's policy before

you waste time submitting an invoice.

What happens if the adjustments are not covered by the warranty? Simply bill the selling dealer for the call, as the manufacturer suggests. However, I dare not repeat the expletives you will hear from the dealer when he receives the bill. That doesn't work, so bill the customer, if you want to waste a ten-cent stamp, and lose his future business.

When you negotiate service-warranty terms with the manufacturer or his representative, be sure you obtain in writing his policy on adjustments of the controls. If he will not pay for the adjustments, you have the alternatives of fighting a losing battle with the selling dealer, alienating the customer, being a liar in order to get paid, or not getting paid. Not much of a choice, is there?

### Call-backs

We have spent years in educating the public that if a set has performed satisfactorily for ten days after repairs, then the repairs are considered completed. Also, a minimum repair carries no warranty, just as a problem different from the original cannot be our responsibility.

Our customers are aware of these policies, but we neglected to educate the manufacturers. To some of them, once we have laid our hands on the set, it becomes our responsibility for the next 30 days, even if the second problem requires shop repair.

If the call-back is within a ten-day period, we "gladly" go back at no charge and correct the problem (at least, if it is considered to be our fault). But is it really our fault? When we install a rebuilt module and it lasts for one, ten, or 30 days then malfunctions, we are expected to return and replace it at no charge for the trip or our time for handling the defective part. In other words, we are told "It is your fault because the part which we built (or rebuilt) went bad, because you installed it." This is like blaming a doctor because the patient dies from a gunshot wound through the heart!

### Incomplete explanation

You say you receive your regular retail rates from the manufacturer? Are you sure? On some warranty tags, "Repaired connection in vertical" is not enough; you must pinpoint which connection. Some time ago, our technician traced an intermittent problem to a panel plug in a "works in a drawer" chassis. He soldered and tightened **all** the connections in order to be certain the problem was corrected. Back came the invoice with the notation "Which pin?" So, don't just state that you have repaired or resoldered a connection on a panel, but pinpoint the exact contact and pin number.

Now, please don't embarrass anyone by asking how to determine the pin connections on certain plugs and connectors. Just pick a number from one to ten; who knows, it just might be a lucky number!

### Not under warranty

Of course, all the manufacturers

supply lists of model numbers currently covered, stating the type and length of warranty. Unfortunately, it seems the printer who publishes these lists must be the same one who prints the service information that arrives three months late.

If you call the selling dealer, he undoubtedly will say, "Of course it's under warranty." I'm not implying that selling dealers lie, but most are under the delusion that **all** products they sell are covered by a maximum warranty. So, if the distributor is handy, obtain the information from him, along with a list of models no longer covered under warranty.

If your invoice is rejected for this reason, about all you can do is cry a lot. For in this case, also, it is almost impossible to appeal to the customer's charity or the selling dealer's generosity. Settle such problems before the service is performed.

### Over 30 days

Have you ever waited more than 30 days for a part? If you ever have such a "rare" occurrence, then it is possible your invoice might be dated over 30 days prior to submission. So, when delays are beyond your responsibility, write a full explanation on the invoice, and then pray that the computer can read!

It is advisable to submit invoices weekly even if there are only one or two. If billing is done monthly, it is likely some will be more than 30-days old.

### Minor and major repairs

Usually, there is no similarity between your idea of a major repair and the manufacturer's definition. In fact, seldom are major repairs even defined. Sometimes it seems we are at the mercy of the whims of either the computer or the person who checks invoices. One invoice for a major repair might be approved, and the next one disapproved.

An intermittent problem requiring considerable time might not qualify as a major repair no matter how much time was required to **find** it. You should write a complete explanation of both diagnosis and repair, hoping the person who checks your invoice has some know-

ledge of intermittent problems.

On the other hand, you also must hope that he doesn't have **too much** technical knowledge, for it is only natural for a technician to judge that **he** could have done the job in less time (especially after it is completed).

I believe the only fair way to determine a major or minor is by the time actually required. However, this does not seem to be the viewpoint of any manufacturer. When we accomplish a minor repair, we are smart technicians. But when it involves a major, we become stupid repairmen who do not deserve to be paid for the time expended. Unfortunately, the latter must be correct, as we accept it without question.

### Incomplete model number

This seems a minor matter to use as an excuse to reject a claim. Certainly, it's evident from the returned parts, the serial number and the registration that the set is a legitimate offspring of the manufacturer.

In these days of abbreviated writing, technicians are inclined to write only numbers (and sometimes only the last three), leaving off letter suffixes and prefixes. If you don't have previous records, you have the alternative of sending someone to the customer's home to copy the number, or not getting paid. And don't rely on the selling dealer having the information. Their writing fingers suffer from the same disease.

Educate your technicians to copy complete model and serial numbers; nothing less will do. Don't expect the billing clerk of the distributor or manufacturer to complete a number, even when it is obvious. Evidently, it is his duty to return it, either to keep you on your toes, or to prove that he is alert.

### Not registered

Original registration of the receiver for warranty is one area where a servicer can be penalized for the neglect of someone else.

Some manufacturer's computers regurgitate any and all labor claims for sets that have not previously been registered.

We thought we had solved the problem by obtaining registration forms and attaching them to the

*(Continued on page 53)*

# MOTOROLA AGC PROBLEMS... Old and New Part 2

By Henry V. Golden, CET



Part 2 explains how solid-state AGC operates in Motorola Quasar color receivers, and gives methods of adjusting and troubleshooting the circuits.

Hundreds of articles and many books have been written about the theory of operation, and the repair of AGC circuits. Such an apparent excess of coverage has been necessary for one main reason: all keyed-AGC systems are closed loops. Of course, there are methods of dealing with the problems, but the fact remains that repairs in AGC circuits often are more difficult than in many others.

When solid state superseded tubes, a whole new group of complications were added. For a thorough discussion of solid-state AGC peculiarities in general, we refer you to the August, 1973 issue of **Electronic Servicing** starting on page 42.

Here are some of the ways in which solid-state components have made AGC servicing more difficult:

- Usually the base/emitter bias is changed to vary the gain of a transistor. Because of the base current, the AGC circuits must handle more power, and this often requires extra AGC amplifier stages;
- Gain of a transistor can be decreased either by raising or reducing the forward bias from that giving maximum gain (how do you know from the schematic which method is used in a particular set?); and
- Transistors are available in both polarities, thus making DC-voltage analysis more difficult.

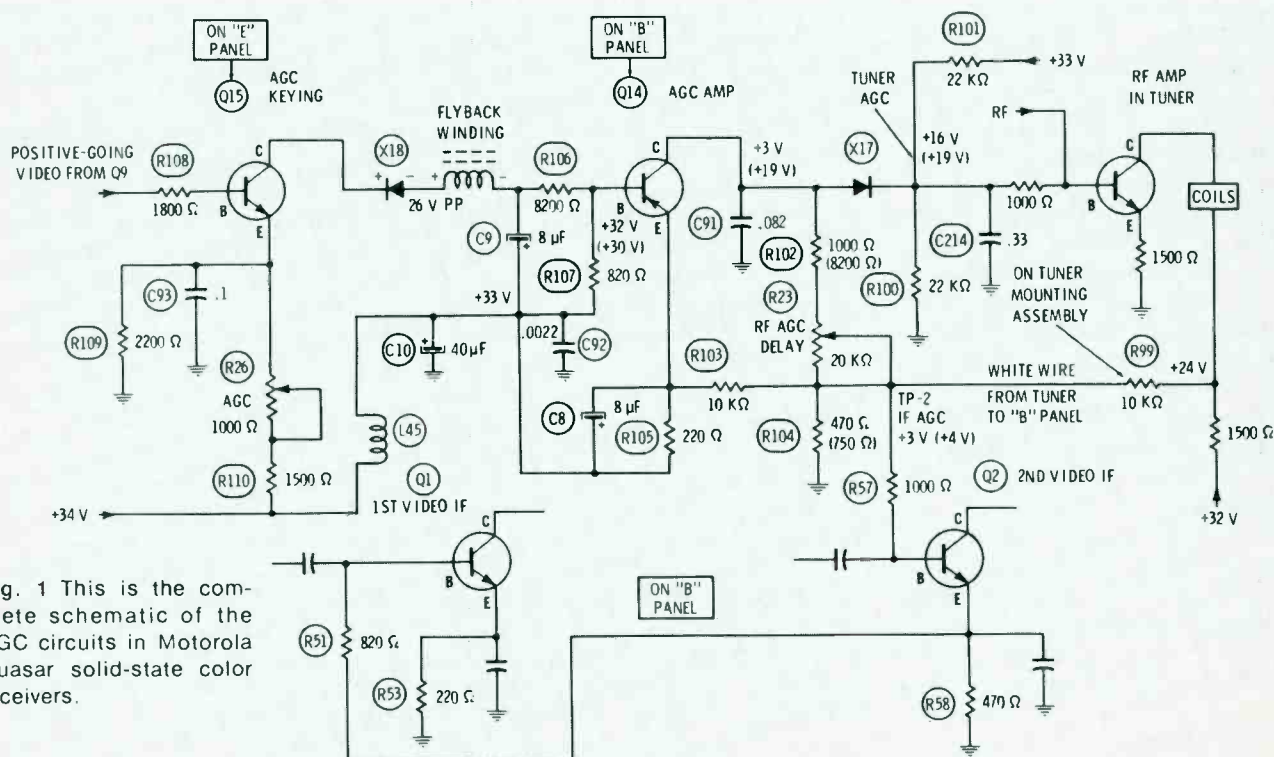

Fig. 1 This is the complete schematic of the AGC circuits in Motorola Quasar solid-state color receivers.



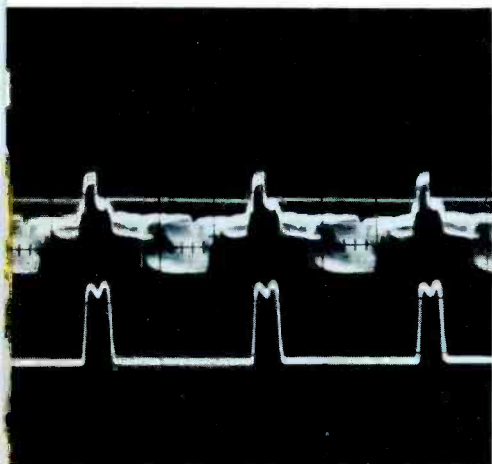

Fig. 2 These are the normal waveforms at the base (top trace) and the collector of Q15 (bottom trace).

Yes, gone are the simple days when gain reduction always was accomplished by applying a negative voltage to the grid of a tube!

The first step of fast solid-state AGC repairs is that you must understand how the circuits operate when all components and adjustments are normal.

### AGC Keying

The AGC keying stage of Figure 1 is identical in principle to many tube circuits, except for the addition of X18 (Photofact 953-1).

Q15, the keying transistor, is an NPN silicon, which means the base must be .5 volt or more positive (relative to the emitter) before collector current can flow. Positive-going video, riding on a positive DC voltage, is applied to the base, and the emitter has an adjustable positive voltage supplied by the voltage divider consisting of R109, R110 and R26. In practice, the emitter voltage is adjusted so that only the sync pulses make the base positive enough for C/E conduction.

Collector voltage consists of horizontal pulses obtained from an isolated winding of the flyback transformer. Waveforms of the base and collector voltages are shown in Figure 2. As in all "keyed" AGC systems, the pulses are used so that no AGC is possible between pulses. This gives some immunity against

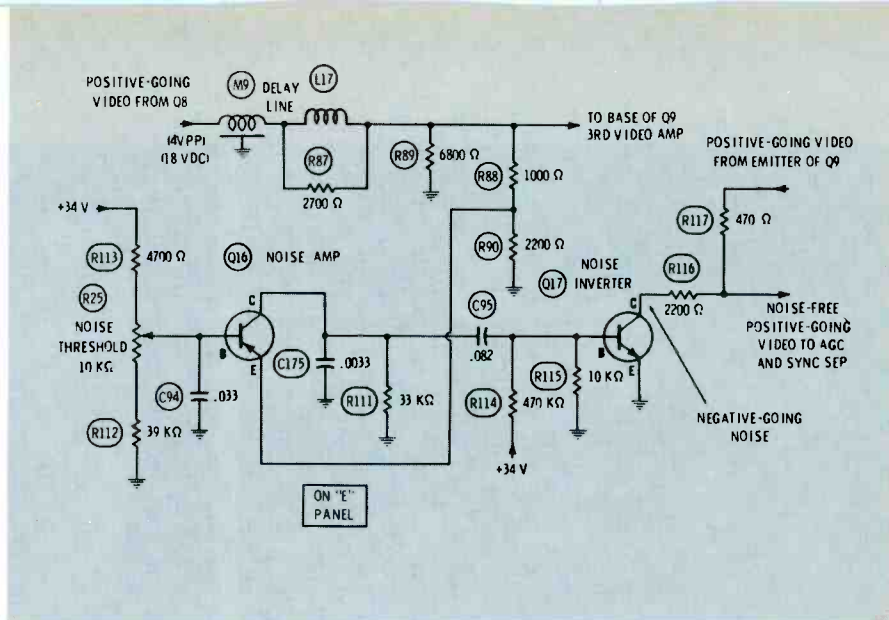

Fig. 3 Two transistors are used in the noise-cancellation circuit. Q16 is biased to cutoff for all except strong noise tips, while Q17 inverts and amplifies the clipped noise. R116 and R117 mix the video that has noise with the inverted noise so the noise components cancel at the input of the AGC and sync separator circuits. Noise can be seen in the picture, but it will not affect the locking or AGC.

"white-outs" caused by strong noise signals.

Output of the keyer stage is a negative DC voltage, which becomes more negative with a stronger station carrier. This negative control voltage forces Q14 (a PNP type) to conduct and supply increased positive voltage forward bias to both the RF amplifier and the IF amplifier transistors, which reduces their gains because of the saturation effect.

### AGC When There's No Signal

When there is no station tuned in, both Q15 and Q14 are biased to cutoff (Figure 1). Forward bias for Q2, the second IF transistor, is obtained from the voltage divider consisting of R105, R103 and R104 (supplies about +1.7 volts) and from the B+ supply of the RF amplifier transistor through R99 (furnishes perhaps +1.5 volts). The total from both these sources is slightly more than +3 volts.

In addition, the emitter voltage of Q2 "follows" the base voltage, and this voltage goes through R51 to the base of Q1, the first video IF transistor. Therefore, both Q1 and Q2 are biased for maximum gain.

Forward bias of about +16 volts for the RF amplifier transistor comes from the voltage divider R101 and R100, and it is the right voltage to produce maximum gain.

At this time, X17 has about +3 volts on the anode and +16 volts at the cathode. Therefore, it does not conduct, but acts as an open circuit, separating the AGC circuit from R100 and R101.

### AGC With A Moderate Signal

When the station tuned in has a moderate signal strength, AGC is applied to the IF transistors, but not to the RF amplifier. Here's what happens.

Both the video and the positive voltage at the base of Q15 increase, so Q15 is biased for a medium amount of conduction. When the flyback winding applies a positive pulse to X18, this is the path of the electron current: from the collector of Q15 through X18, the flyback winding, R106, R107, B+, R110, R26 (AGC control), the emitter of Q15, and through Q15 to the collector. The current causes a voltage drop across R106 and R107, and C9 acts as a peak-reading input filter capacitor that removes most of the pulses from that end of the flyback winding.

Incidentally, the DC voltage at both ends of the flyback winding measures negative relative to B+. So the part of C9 negative voltage that goes through the voltage divider (R106 and R107) is forward bias to the base of Q14, which is a PNP-polarity transistor.

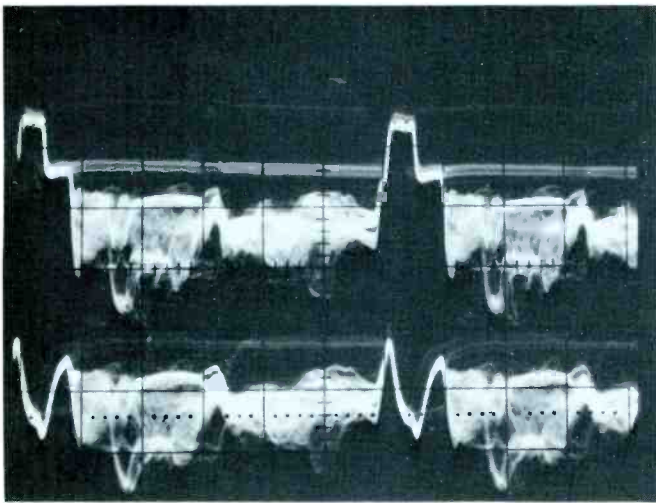

Fig. 4 The top waveform is the normal video at the base of the AGC keyer transistor (Q15), and the bottom waveform shows the inverted horizontal sync pulse that resulted from a wrong adjustment of the noise-threshold control.

Fig. 5 In extreme cases of cross-modulation distortion, the blanking bars of another channel can be seen along with the normal picture. The effect is exaggerated here because the video of the desired channel faded out between scenes. Less severe overload makes the picture look grainy.

The forward bias makes the collector/emitter path of Q14 the equivalent of a medium-value resistor, which is in series with R102 and R23. (Without an input signal, Q14 was open, which effectively disconnected R102 and R23.) Q14, R102 and R23 are paralleled across R103; therefore, the positive voltage at TP-2 (IF AGC point) is increased about a volt. This decreases the gain of Q1 and Q2.

Although the DC voltage at the collector of Q14 increased more than the IF AGC, it is less than +16 volts. So X17 remains reverse biased (an open circuit) and no AGC is applied to the RF amplifier.

#### What About X18?

The diode X18 would not be needed if the AGC keyer were a tube. With a tube, rectification of each positive-going horizontal pulse at the plate produces a negative DC voltage. And, of course, a negative plate voltage can't cause current flow through the tube. Therefore, the negative voltage is stored by the peak-reading capacitor until the next pulse.

Not so, if the keyer is an NPN transistor. Negative DC is generated the same, but it immediately leaks through the collector-to-base junction of the transistor. Virtually no negative voltage is retained, so the circuit is too inefficient to furnish

AGC signals.

The polarity of X18 is such that it passes the positive pulses, but it prevents the negative voltage stored in C9 from flowing to the collector.

There is some disagreement about whether Q15 or X18 is the actual rectifier. Someone might say the positive tip of a pulse turns on the diode, and after the pulse passes, the diode turns off. But really, that's a pretty good definition of "rectifier."

Proof is obtained by application of a "law" borrowed from Editor Babcoke, which goes like this: **When a DC voltage is produced by rectification, it is negative if taken from the anode, and positive if taken from the cathode.** Now, in the circuit, current flow from the pulses causes the collector of Q15 to become positive, while the cathode of X18 is positive and the anode is negative. Only the diode fulfills the rule for rectification. Therefore, Q15 is effectively a control resistor, and X18 is the rectifier. Together they make up the AGC-keying rectifier. Additional proof can be obtained by placing a short from collector-to-emitter of Q15. A large negative voltage will be measured at C9. Q15 is not necessary for rectification.

These facts offer a valuable tip for troubleshooting: **if X18 is either shorted or open, there will be no AGC action.**

#### AGC With A Strong Signal

When the station signal is very powerful, AGC gain reduction is applied to the RF stage to prevent overload of the mixer in the tuner, and the IF AGC remains nearly the same as for a moderate signal.

The video and positive DC signals at the base of Q15 both are increased over the conditions listed for moderate signal strength. A higher negative voltage is stored in C9, increasing the forward bias of Q14, causing more C/E conduction, which slightly raises the positive voltage at TP-2, the IF AGC source. If allowed to stand, this condition would reduce the IF gain, but notice what happens next to offset it.

Positive voltage at the collector of Q14 also is increased, which makes the anode of X17 more positive than the fixed +16 volts at the cathode. Therefore, X17 conducts and passes the higher voltage on to the grid of the RF amplifier transistor, reducing its gain.

The increased forward bias of the RF transistor forces the collector to draw more current through the 1500-ohm supply resistor, thus reducing the collector voltage. Because a sample of this voltage is brought through R99 to the IF AGC, the decreased collector voltage attempts to reduce the IF AGC voltage, which had been increased by the direct action of Q14. The net

# Stocking only 49 ECG™ semiconductors is like having thousands of audio transistors on hand.

Manufacturers of TV, radio and stereo systems have audio transistor replacements listed under thousands of different part numbers.

But, thanks to the Sylvania ECG semiconductor replacement guide, you can replace practically all of them with just 49 different transistors.

And that can save a lot of hunting and stocking, especially when you're a busy service dealer.

For example, if you need a low-noise, high-gain NPN-silicon transistor for an audio preamp, check out our ECG-199. It fits a lot of sockets.

And if import parts are bugging you, our ECG-158, 176, 226 and 226MP are direct replacements for parts like the 2SB405, 2SB474 and 2SB492 plus a lot of others you'll find in our guide.

But, our cross-reference guide (ECG-212E) lists a lot more than just audio transistors. It lists over 75,000 parts that can be replaced with a minimum number of Sylvania ECG parts.

For you, it means one source for practically all your replacement needs, including industrial components.

What more could anyone ask for?

**GTE SYLVANIA**

GTE Sylvania Electronic Components, Waltham, Mass. 02154

result is that the AGC voltage applied to the IF transistors remains approximately the same as when the station signal was weaker, but the RF transistor has gain-reducing AGC applied to it. A very clever circuit, but defects in this extra tie-in might cause mistakes of diagnosis, if you don't understand all the implications.

One more basic circuit needs discussing before we can get into troubleshooting: the noise inverter.

### Noise Amplifier And Inverter

Circuits of the noise-cancelling stages are shown in Figure 3. There are two basic functions, clipping and inversion/amplification.

Positive-going video from the base of Q9, the 3rd video amplifier, is fed to the emitter of Q16, while the base receives only an adjustable positive DC voltage from the "noise threshold" control.

Base/emitter bias of the PNP transistor must be such that it is cut off, and only the noise components having more amplitude than the sync pulses force Q16 into conduction. Because Q16 is a PNP polarity, a higher positive voltage at the emitter acts as forward bias. Only during noise bursts does the transistor have gain.

Output signal (if any) from the collector of Q16 is coupled to the base of Q17 through a small capacitance (C95) which attenuates the low frequencies. Q17 amplifies and inverts any signal from Q16, so at the collector of Q17 there either should be no signal, or negative-going noise.

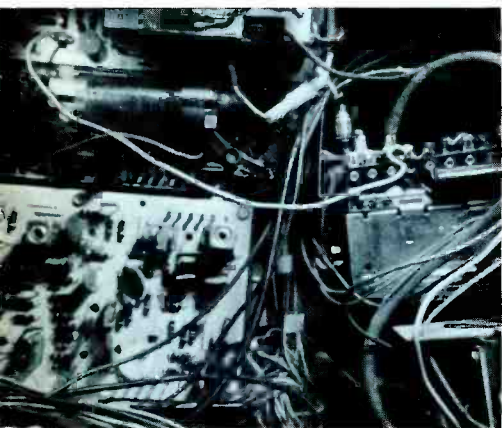

Fig. 6 Here is the white wire between the tuner and the "B" panel that contributes part of the IF AGC voltage. Without this additional voltage the IF gain will be too low.

R116 and R117 mix together the positive-going video containing positive-going noise and the negative-going noise so the two noise signals cancel, leaving only noise-free video.

Notice that the noise circuitry does not have any automatic action. Any radical change of video can upset the noise-cancellation effect. Less video amplitude at the emitter represents insufficient forward bias, so the noise cancellation would be lost. On the other hand, an increase of video might cause amplification and inversion of sync tips, which could degrade the vertical and horizontal locking (see waveforms in Figure 4).

Incidentally, the characteristics of Q16 and Q17 are quite important; therefore, I advise only Motorola 48-134910 transistors be used for replacement.

### Troubleshooting Tips

Before now, I have not mentioned that much of the signal circuitry of these Motorola Quasar color TV receivers is on removable panels. If you have a stock of new or factory-reconditioned panels, a large percentage of the repairs can be made merely by replacing panels.

On the other hand, the panels can be repaired without undue difficulty, if you would rather. Either way, I believe a technician will be ahead of the game by knowing how the circuits operate and how to repair them.

Notice that the "B" panel (video and sync), the "E" panel (video IF's) and the tuner all play a part in AGC operation.

### AGC adjustments

Two factors make AGC and noise threshold adjustments critical in these sets. First, solid-state tuners are more susceptible to cross-modulation (windshield wiper) when overloaded than are tube versions. Also, the noise cancellation circuit can degrade the locking if it is misadjusted.

Here is the method I use to make the adjustments:

- select a channel having a strong signal, and correctly adjust the fine tuning;
- adjust the RF AGC Delay (R23) near the center of its range;
- adjust the AGC control (R26) towards increased contrast until the

picture barely becomes unstable;

- adjust the Noise Threshold for a stable picture; then repeat adjustments of AGC and Noise Threshold for both maximum contrast and a stable picture;

- at this time, the picture might have snow or adjacent-channel interference (windshield-wiper effect); so

- adjust the RF AGC Delay between the points giving snow or adjacent-channel interference. See Figure 5 for an example of such interference.

Some compromise of these adjustments might be necessary, if your reception includes both strong and weak signals.

### The white wire

Between the tuner and the "B" panel is a white wire (see Figure 6). This is the connection between the RF collector supply and the IF AGC that is shown in Figure 1.

In one instance, the white wire had broken at the tuner. The symptoms were no snow off channel, and a fair picture on channel. In other localities, there might have been some snow in the picture. The open circuit decreased the AGC voltage at the IF transistor, although a maximum adjustment of the AGC control brought the voltage up nearly to normal.

Following tuner replacement, the white wire was pinched underneath the tuner so that it was shorted to ground. There was no sound and no picture on all channels.

### Open transistor

The picture was overloaded on station, but had normal snow on an unused channel. Adjustment of the AGC control had no effect. "No AGC" was the preliminary diagnosis.

Across the terminals of C9 I measured about -20 volts on channel and nearly zero with no input signal. That proved the keyer stage was operating okay. The IF AGC measured approximately the normal +3 volts off channel, but about the same on channel, an indication that something in the Q14 stage was not working. To make a long story short, I found Q14 was open.

### No AGC

Outwardly, the symptoms were  
(Continued on page 53)

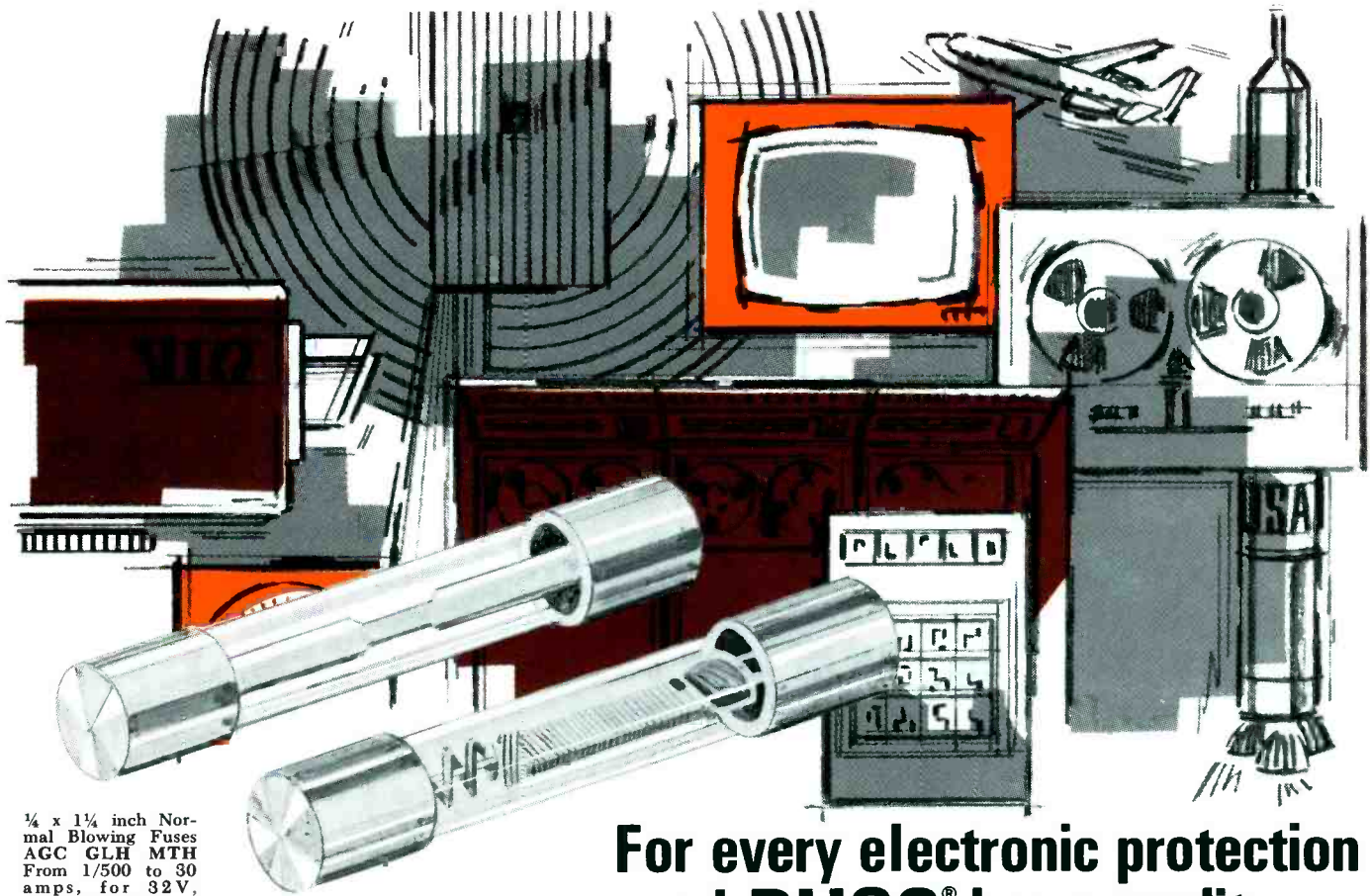

¼ x 1¼ inch Normal Blowing Fuses  
AGC GLH MTH  
From 1/500 to 30  
amps, for 32V,  
125V, or 250V

¼ x 1¼ inch Time Delay Fuses — From 1/100 to 30 amps, MDL MDX for 32V, 125V, or 250V

## For every electronic protection need **BUSS**® has a quality Fuse and Fuseholder



HWA Fuseholder for GMW Subminiature Fuses



Series HH and HI In-the-Line Fuseholder for ¼ x 1¼ Fuses



HTA Space-Saver Panel-Mounted Fuseholder for ¼ x 1¼ Fuses (solder terminals) also HTA-DD, 3/8" Quick-Connect Terminals and HTA-HH, ¼" Quick-Connect Terminals



HKL Lamp Indicating - Panel - mounted Fuseholder for ¼ x 1¼ Fuses



HMR RF-Shielded Panel-Mounted Fuseholder for ¼ x 1¼ fuses and HMS for ¼ x 1" fuses — Solder or Quick-Connect Terminals



HLD Visual-Indicating Panel-Mounted Fuseholder — for ¼ x 1¼ Fuses — Solder or Quick-Connect Terminals



NEW: BUSS SNAP-LOCK rear panel mounted fuseholder for ¼ x 1¼ fuses — a "snap" to install  
Ask for BUSS Bulletin SFH-14

The BUSS line of fuseholders is as complete as the BUSS line of fuses, covering all applications.

If you've got a circuit to protect, BUSS has the fuseholder as well as the fuse to protect it.

For more information on the complete line of BUSS fuses, fuseholders, fuseblocks, and fuse clips, write for a free copy of BUSS Bulletin SFB.



BUSSMANN MANUFACTURING  
a McGraw-Edison Company Division  
St. Louis, Missouri 63107





By Robert L. Goodman, CET

# Servicing a horizontal module

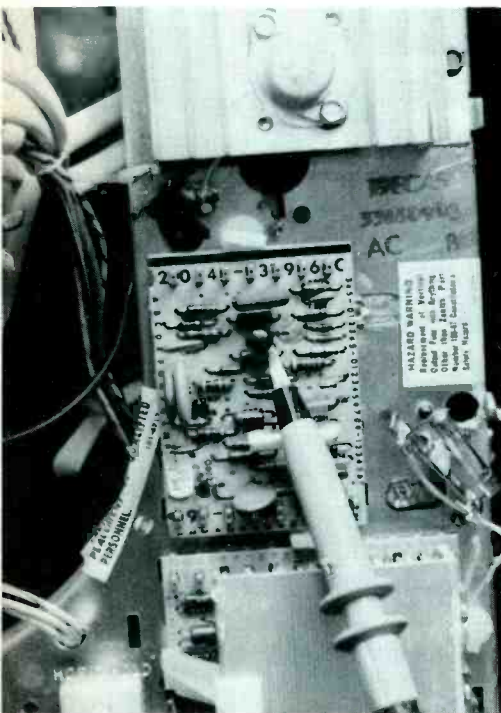

Fig. 1 In the center of this picture of the 19EC45 Zenith chassis is the 9-90 horizontal-oscillator module. Above it is the horizontal-output transistor, mounted on a heat sink. Shaft of the horizontal hold can be seen at the lower left, and the vertical module with heat sink is at the lower right.



Fig. 2 Easier repairs are possible by using a vise to hold the modules.

*There are no standard solid-state circuits which are common to several makes of television receivers. Very little generalization is possible, and the circuits should be studied separately. Theory of operation and troubleshooting of the 9-90 horizontal module used in many Zenith color sets are covered here.*

Although the general purposes of horizontal oscillators are the same for either solid-state or tube-powered TV receivers, there are many differences that greatly affect efficient troubleshooting.

The example for this article is the 9-90 horizontal-oscillator module used in the 1974 and 1975 vertical-chassis Zenith color sets. Circuits of the older 9-57 module are quite similar, so much of the information applies also to those modules. However, the 9-57 and 9-90 modules have different physical sizes and connectors, and cannot be interchanged. A 9-90 module in a Zenith 19EC45 chassis is shown in Figure 1.

Of course, these modules can be replaced with known-good ones, either as a test to determine if the defect was in the original module, or to complete the repair in case the new module restores the performance. However, they are easy to repair. The transistors plug in, and other parts can be unsoldered and replaced without undue difficulties.

Modules can be repaired more conveniently if they are fastened in a jig of some kind. One such module holder (Figure 2) is the **Pana Vise**, which is marketed by the Colbert Industries of South Gate, California.

## Preliminary Servicing

My experience over a period of

years indicates that the following general preliminary tests will uncover perhaps 60% of the problems. Check these things:

- look for loose connections at the terminals where the module plugs in;
- make a visual inspection for obvious bad joints or loose components;
- test all solid-state devices;
- replace any discolored or burned resistors; and
- repair any cracks of the PC board.

## DC voltages

Without spending too much time at this point, check to see if the module is obtaining both the +24 and +120 supply voltages. There's little need to check a circuit that isn't getting any power!

## General Symptoms

Figure 3 shows a block diagram of the horizontal sweep system. In this article, we shall cover only those circuits to the left of the dotted line.

Generally stated, the AFC circuits and diodes have to do with horizontal locking. However, defects there can cause a large change of frequency. The oscillator can give an incorrect frequency, but not poor locking. Neither frequency nor locking can be changed by the driver stage. It is responsible only for correct waveform and sufficient drive to the base of the horizontal output transistor. This drive mainly determines width and linearity.

## AFC Circuits

Two waveforms are necessary for correct Automatic Frequency Control (AFC) operation. Differences in the phase of the horizontal sync and a sample of the sweep waveform produce a control voltage,

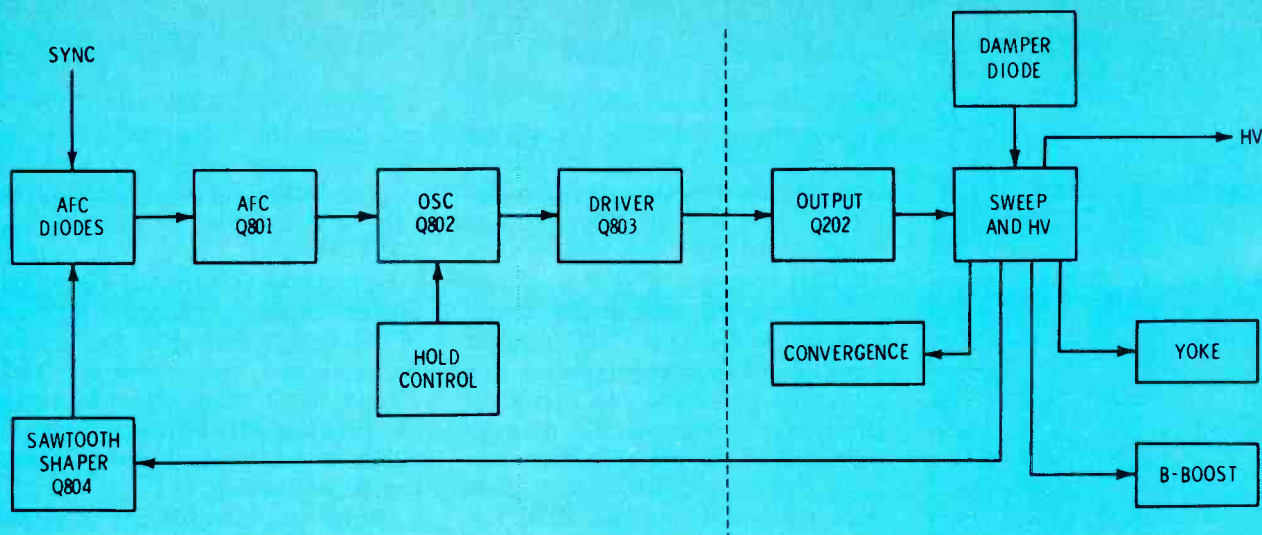

Fig. 3 A block diagram of the 19EC45 horizontal-sweep circuit makes the functions more clear.

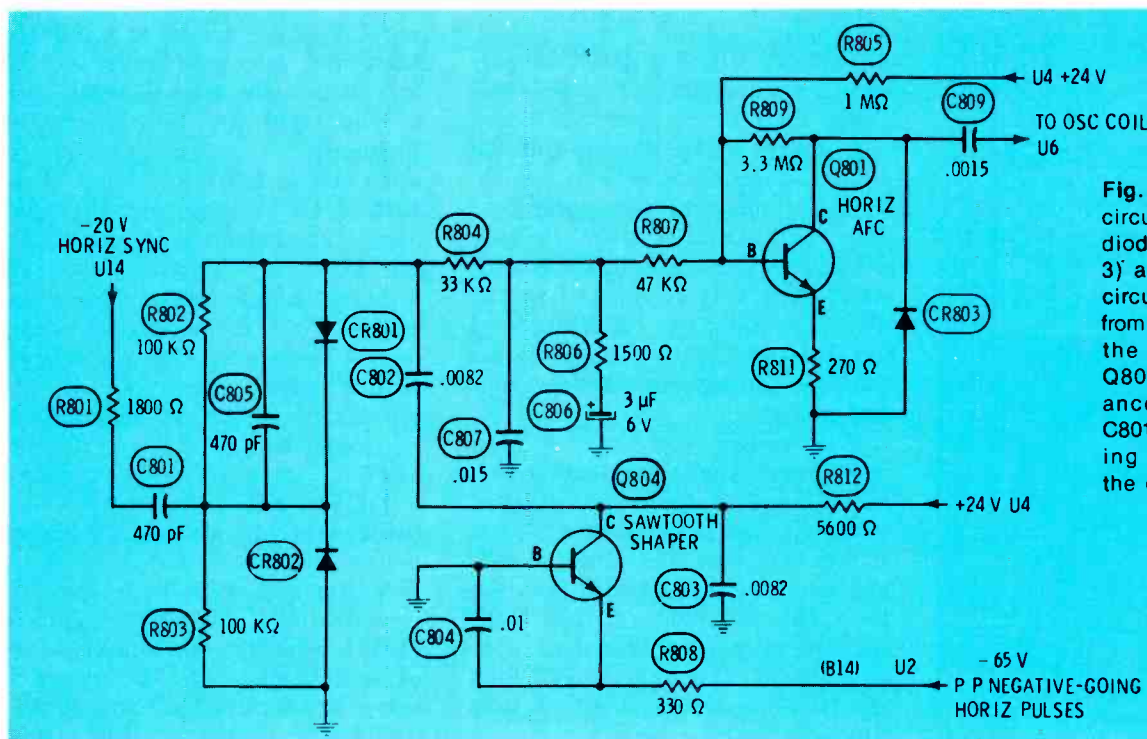

Fig. 4 Waveforms and circuits around the AFC diodes (Photofact 1377-3) are similar to tube circuits. Control voltage from the diodes changes the C/E resistance of Q801, and this resistance in series with C801 changes the tuning and frequency of the oscillator.

which is used to stabilize the locking.

Negative-going sync pulses of about 20 volts p-p are applied to terminal U14 (see the schematic of Figure 4). After they pass through R801 and C801, the pulses reach the common cathodes of CR801 and CR802, which appear to be germanium diodes.

Also, negative-going pulses (65 volts p-p) from a winding of the horizontal output transformer are applied to terminal U2 (B14 on the 9-57 module). These pulses are integrated into sawteeth in two steps.

First, R808 and C804 change them into rounded sawteeth, then C803 and the collector resistance of C804 shape them more like traditional sawteeth. No phase inversion occurs in Q804, because the input signal is fed to the emitter. From the collector, the sawteeth go through C802 to the anode of CR801.

Rectification of the sync and sweep signals by CR801 and CR802 is quite complex, involving series and shunt peak-reading actions. These few facts are the only ones necessary for troubleshooting:

- sweep sawteeth alone (without

sync) produce a positive voltage at the common cathodes, and nearly zero voltage at the anode of CR801;

- sync pulses alone also give a positive voltage at the cathodes, and a zero voltage at the anode of CR801; and

- both signals together produce a positive voltage at the common cathodes, and a DC voltage that might be zero, negative or positive (depending on the phase of the two signals) at the anode of CR801.

This DC voltage at the anode of CR801 (output of the phase detector) is the **control voltage** used to

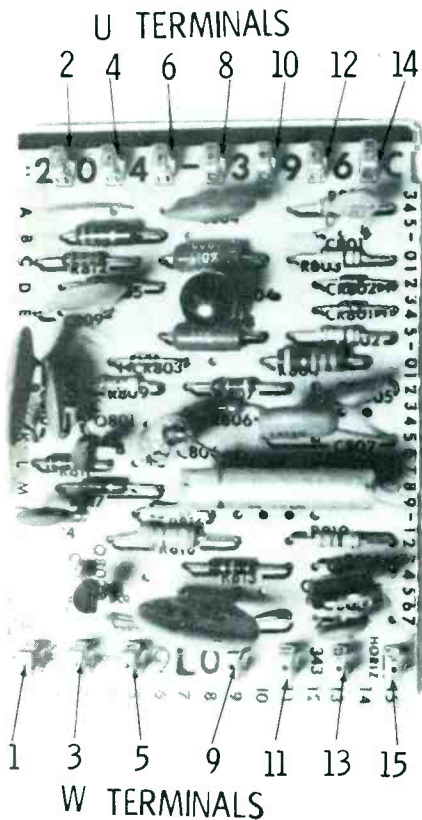

Fig. 5 Plug-in connections are divided into "even" "U" and "odd" "W" terminals at opposite ends of the module.

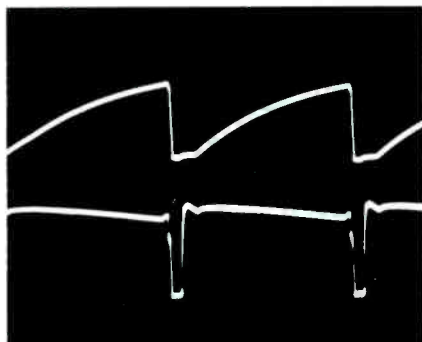

Fig. 6 Waveform at the top shows the normal 15-volt p-p sawteeth at the anode of CR801, and the bottom trace is the 9-volt p-p sync pulses at the common cathodes of CR801 and CR802. DC voltage at the cathodes is +7.5.

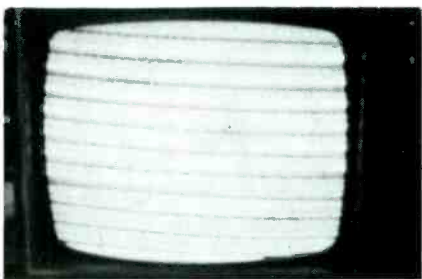

Fig. 7 Many diagonal bars prove the horizontal oscillator is far out of frequency.

bring the oscillator into lock with correct phase. Normally, the voltage is nearly zero, but if the phase begins to change, the voltage swings either positive or negative—as needed—to pull the phase back where it belongs.

Following the path of the control voltage, R804 and C807 remove most of the horizontal pulses, the undesired waveforms left over from the phase detectors. To prevent overshoot of the control action that gives "piecrust", R806 and C806 store the control voltage. R807 isolates the control voltage from the bias voltage of Q801.

Up to this point, the AFC circuit might just as well have been in a tube set. But from here on, it's solid state.

Forward bias for Q801 largely comes from R805 (although some comes from R809, as we shall see). The control voltage flowing through R807 changes the base bias, which, in turn, changes the collector/emitter resistance of Q801. Because the C/E resistance is in series with C809 (which is connected to the oscillator coil), the resonant point of C224 and L204 is changed in the direction giving correct frequency and phase.

The circuit has one hidden peculiarity. Apparently, the collector voltage of Q801 is obtained solely through R809 from the base. If this were true, the collector voltage would be less positive than the base. However, diode CR803 rectifies part of the oscillator signal that feeds back through C809. This rectification supplies about +5 volts to power the collector.

### Terminal Numbers

So many numbers appear on the modules that it's difficult to locate the ones for the plug-in terminals. Figure 5 shows the correct numbers and locations, with the board rotated in the same direction it is when plugged into the chassis. Notice that all the "U" (even) numbers are along the "top" edge; and the "W" (odd) numbers are along the "bottom" edge. In some cases the "U" or "W" might be obscured partially.

### AFC Symptoms And Cures

No defect in the AFC circuit

(Q804, Q801, CR801 and CR802) can cause the horizontal oscillator to stop. Therefore, only symptoms of poor locking or wrong frequency can be caused by defects in the AFC.

Correct waveforms at the AFC diodes are shown in Figure 6. One of the first instrument tests should be to verify the amplitudes and waveforms. **If either signal is weak, the locking will be loose; and if either waveform is missing, there can be no locking.**

Here are some of the possible defects and symptoms:

- if CR801 is shorted or open, the horizontal will be far out of lock, with many bars slanting down to the **left** on the raster;
- if CR802 is shorted or open, the horizontal also will be far out of lock, with many bars slanting down to the **right** on the raster (see Figure 7);
- if C806 or C807 is shorted, there will be no locking, but the hold control can bring the picture almost into lock;
- if Q801 is open or has a collector/emitter short, the horizontal will be far off frequency, with perhaps 10 to 20 diagonal bars;
- if CR803 is open or shorted, the horizontal will be far out of lock; and
- if Q804 has a C/E short, the horizontal will lock, but perhaps not so tight as usual.

A blurred waveform can be viewed at the anode or cathode of CR801 when the horizontal is out of lock (Figure 8). The effect is more pronounced if one of the diodes is defective, but some thought and experience is necessary before the analysis will be useful. In this case, DC voltage or ohmmeter tests around the diodes will be more accurate in finding the defect.

### Substituting the control voltage

An effective test to prove whether a wrong horizontal frequency is caused by the AFC or the oscillator stage is to ground the junction of C807, R804, R806 and R807. This provides a zero voltage at that point which simulates the zero control voltage from the diodes when the locking is correct. If the horizontal now is near the right frequency (picture drifting across the screen



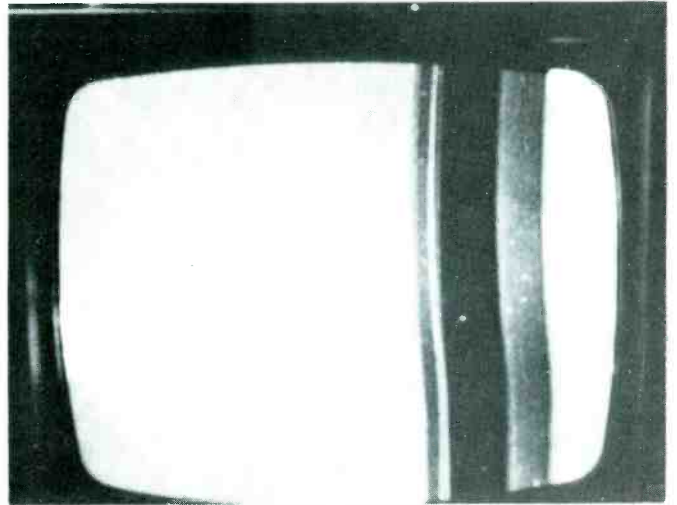
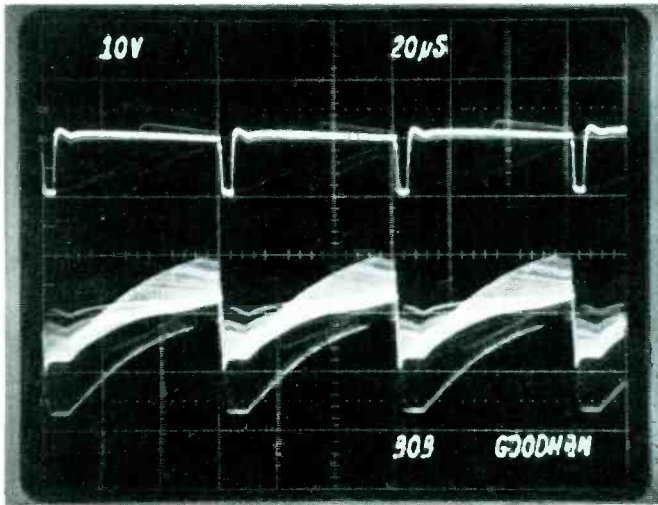

Fig. 8 Top waveform is the normal one at the common cathodes of CR801 and CR802. If CR801 shorts, both sawteeth and pulses are present, and the control voltage becomes positive so the horizontal is out of lock. The blur is caused by the pulses moving sideways very rapidly across the stationary sawteeth.

Fig. 9 Here is an example of correct frequency (one picture, upright). But because there is no locking, the picture drifts slowly sideways. A good test is to ground out the control voltage coming from the diodes. Then if the frequency is right, it proves the oscillator circuit is okay.

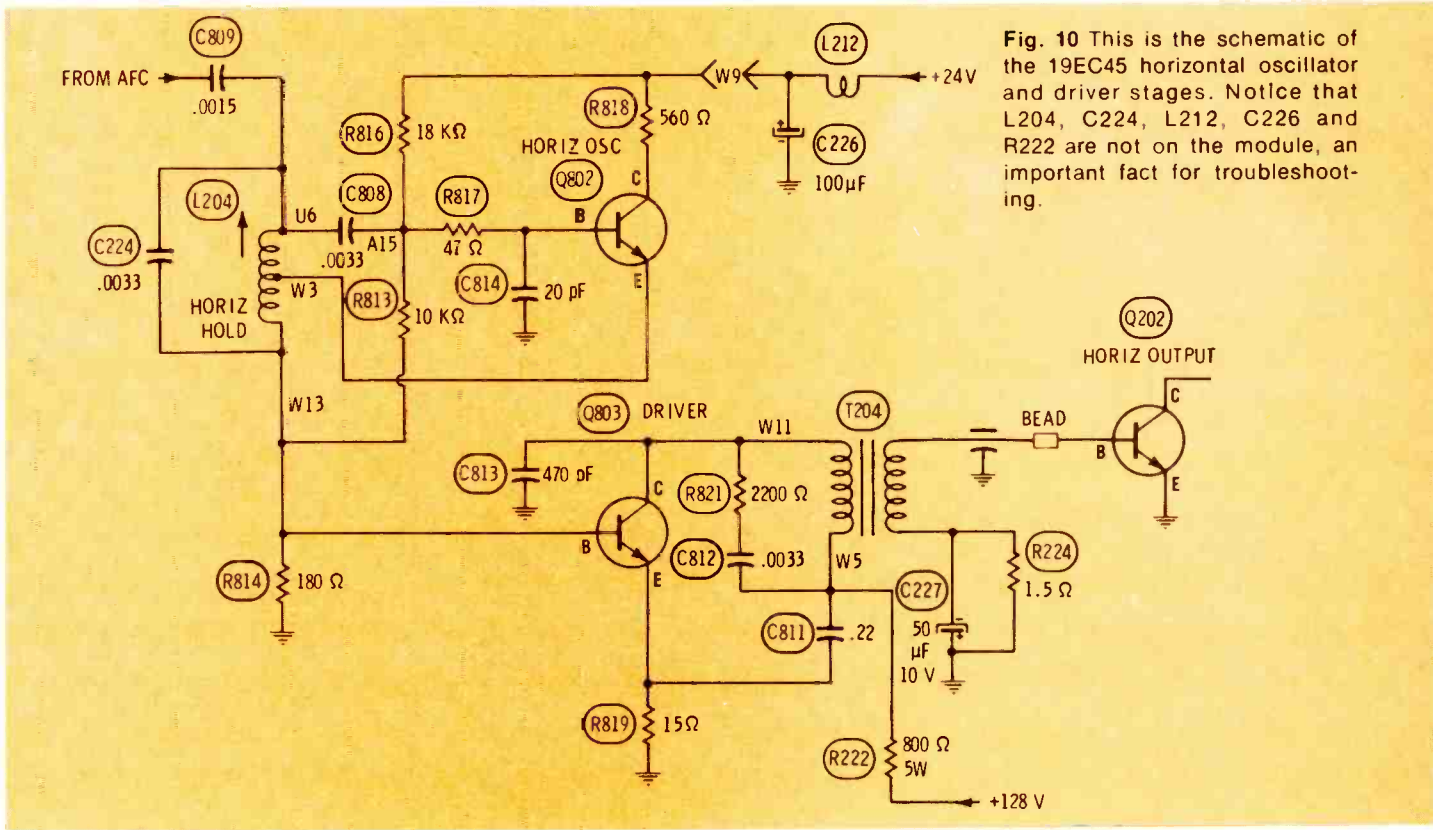

Fig. 10 This is the schematic of the 19EC45 horizontal oscillator and driver stages. Notice that L204, C224, L212, C226 and R222 are not on the module, an important fact for troubleshooting.

as in Figure 9, or with only a couple of diagonal bars), the defect is in the diodes, or some of the components connected to them. But if many diagonal bars remain, the trouble probably is in the Q801 stage or the oscillator.

#### Normal locking

Incidentally, the normal locking is so tight that maximum adjustment of the horizontal hold control (core of the oscillator coil) can't throw it out of locking. This gives you a standard with which to judge

the locking.

#### Oscillator Symptoms And Cures

A partial schematic of the horizontal oscillator and driver stages is shown in Figure 10. The oscillator

is an emitter-coupled sine-wave type in which L204 and C224 are the main components for determining the frequency. Forward bias is

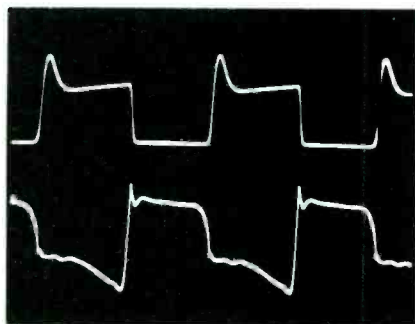

Fig. 11 Lower trace is the 2-volt p-p base waveform of Q803, and the waveform at the top is the 170-volt p-p collector signal.

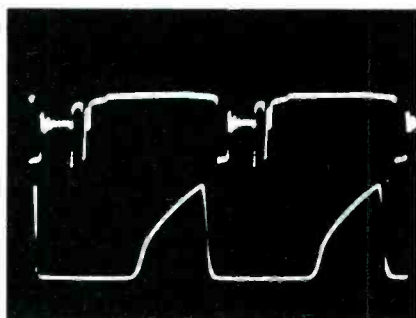

Fig. 12 Trace at the top is the complex 8 volt p-p normal waveform at the base of Q202, the horizontal-output transistor. But when the transistor is unplugged, the waveshape is nearly a sawtooth (lower trace).

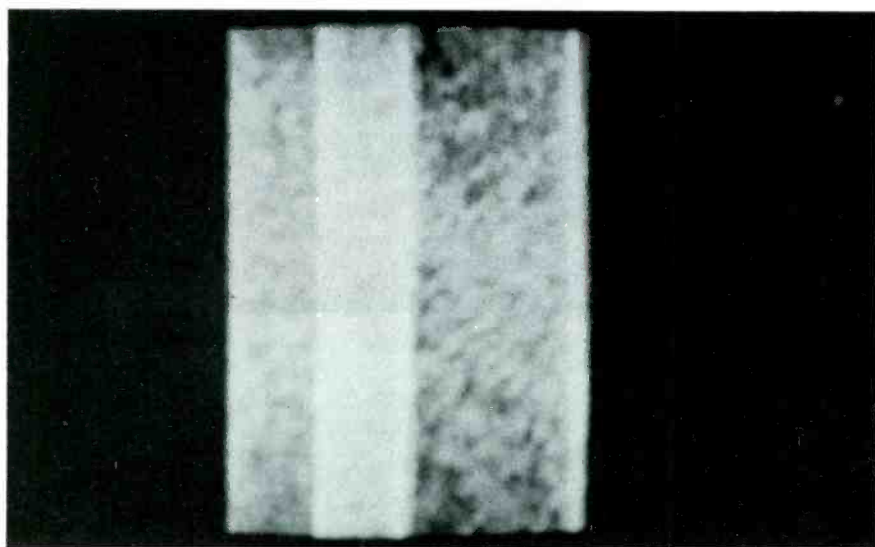

Fig. 13 A narrow raster with foldover in the center might be caused by insufficient drive to the base of the output transistor.

furnished by R816 and R813. However, base rectification of the signal there makes the DC base voltage less positive than the emitter.

Emitter current of the oscillator flows through L204, and then through R814 to ground. Voltage drop across R814 is the input signal for Q803, the driver transistor. Therefore, any defect which makes Q802 draw excessive emitter current results in too much forward bias for Q803. This makes Q803 run hot, and the symptom might mislead you into suspecting a defect in the Q803 stage instead of the oscillator.

Figure 11 shows the correct input and output waveforms for Q803.

### Drive Waveforms

While we are discussing waveforms, a very unusual one (Figure 12) is the normal waveform at the base of the horizontal output transistor, Q202. I wouldn't attempt to analyze why it is that shape. The second unique feature is that it becomes more like a tube-type waveshape when the transistor is unplugged. **There is no counterpart in tube circuits for this change of waveform.**

### Not The Module

What is the next step if you are certain a defect is in AFC or oscillator stages, but a new module doesn't fix it? Answer: Check the oscillator components that are

mounted external to the module.

Two that can stop oscillation or change the frequency are L204 (oscillator coil) and C224. If L212 opened, there would be no +24 supply for the oscillator.

Another off-module component is R222, which supplies collector voltage for Q802. Check it and C811 for loss of collector voltage.

### Drive Problems

Narrow width with foldover in the center (Figure 13) is not a common symptom, but it usually indicates insufficient drive to the base of Q202, the horizontal output transistor.

It isn't wise to allow the set to operate very long with this symptom. Operation longer than perhaps 15 seconds might result in failure of Q202.

### Summary

Circuits and waveforms around the AFC diodes are very similar to those of tube circuits. Many of the same tests work fine.

The oscillator is comparable to a sine-wave tube oscillator with reactance-tube control of locking. Troubleshooting is similar, except for the AC and DC voltages, which are much lower.

Tube circuits usually do not have a separate driver stage, although some use pentode tubes that give the same effect. Waveshapes in the driver transistor stage are almost square waves; and that's quite different from the drive signal for output tubes.

If the preliminary tests have been performed and they revealed nothing significant, check the key waveforms using the ones given in this article or those with the complete schematic as examples. Then, after you have located the stage that has the defect, use DC voltage analysis and ohmmeter tests to find the bad component.

The sequence is the same as that for troubleshooting tube equipment. But there are two distinctive differences. Transistors demand a low forward bias, but it is a critical one. Also, some ohmmeter tests can give drastically wrong answers, if the ohmmeter voltages cause conduction of the junctions of the transistors. □

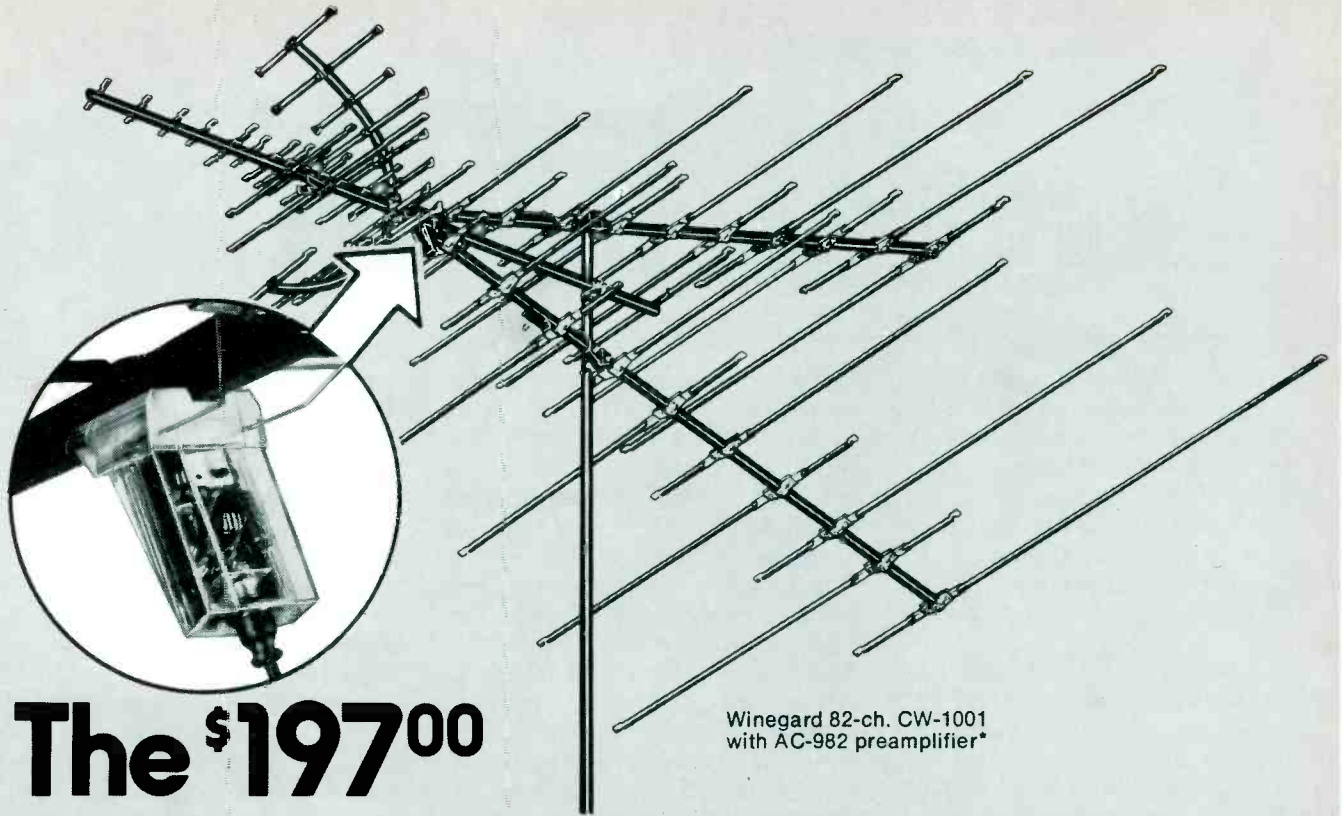

Winegard 82-ch. CW-1001  
with AC-982 preamplifier\*

# The \$197<sup>00</sup> package that solves the toughest ones!

Our most expensive antenna package is one of our best sellers. And that's not too surprising.

There are lots of people who live in difficult reception areas who demand the best possible picture quality. And they are willing to pay for it.

To satisfy that demand for excellence in TV reception, antenna dealers who have "tried them all" frequently end up recommending the CW-1001 with Winegard's special high gain, low noise preamp. A great combination that makes the picture look good and makes *you* look good.

## What Makes The CW-1001 Different? Check These Winegard Features:

- Unique wedge design offers increased signal capture area in a much shorter and more compact antenna.
- VHF vertical beam phasing rejects interferences such as airplane and auto ignition noise.
- Patented UHF driven element assembly and patented parabolic reflector screen provide unprecedented gain in an all band antenna.
- Special lightning protection circuit prevents static electricity build-up and arcing.
- FM control elements allow attenuation of strong FM signals where they interfere with TV reception.

- Choice of 300 or 75 ohm downlead.
- New truss construction with three mast clamps and super strong ellipsoidal booms of special aluminum alloy team up to provide rugged resistance to wind and weather.

## Special High Gain, Low Noise Preamps

- Winegard's finest. Designed for the ultimate in deep fringe reception.
- High gain and low noise insures near perfect, snow-free color.
- Two-section high pass filter and switch selectable FM trap.
- Unique lightning protection circuit.
- For 75 ohm downlead only.

This great combination of antenna and preamplifier represents the finest effort of twenty years of Winegard television reception research. See your distributor or write Winegard Company.

\*For VHF only, use CW-2002 with AC-913 preamplifier.

**WINEGARD**  
TELEVISION SYSTEMS  
Winegard Company / 3000 Kirkwood Street  
Burlington, Iowa 52601

# Reports from the test lab

By Carl Babcoke

*These monthly reports about electronic test equipment are based on actual examination and operation in the ELECTRONIC SERVICING laboratory. Observations about the performance, and details of new and useful features are spotlighted, along with tips about how to use the instruments for best results.*

The B&K Precision Model 282 Digital Multimeter is a good example of the new trend toward instruments with a higher-order of accuracy, combined with digital read-outs giving excellent visibility without parallax reading errors.

## Digital Characteristics

Although digital multimeters (DMM's) and conventional VTVM's are both used for the same kind of measurements, there are as many differences between them as exist between VOM's and VTVM's. (I am grouping VTVM's and solid-state meters together here because they operate externally the same.) Even the terms are different, such as "over-range," "3-1/2 digits" or "auto-ranging."

### How many digits?

All digital meters use segmented

figure "8" numbers whose 7 segments can be lighted or not to display numbers from 1 to 9. (For more information, refer to the article on DMM's starting on page 14 of the March, 1974 issue of **Electronic Servicing**.)

Therefore, one digit can show numbers from 1 to 9 inclusive, two digits display from 1 to 99 inclusive, and 3 digits read from 1 to 999 inclusive.

In other words, the number of digits displayed is the most important limitation of the accuracy, regardless of the electronic accuracy and stability.

Most service-type DMM's also include a number 1 located at the extreme left. This is called a "1/2 digit" and is very useful to indicate voltages above the basic range (over-ranging condition) and to give increased accuracy to many readings having a 1 as the first digit.

A display of 3-1/2 digits appears to be a good compromise between cost and accuracy, and the B&K 282 has that number.

### Over-ranging

Analog instruments indicate a reading above the range selected by the pointer moving to the right

beyond the calibration figures. Digital meters require an over-range indication, otherwise a reading of 999 volts might indicate the correct reading, or it might mean the voltage was much higher but couldn't be displayed.

In the B&K 282, an over-range of 200% or more causes the first digit (1) to light and the other three to be dark.

Another advantage of the 1/2 digit is that it also provides better accuracy on some readings. Suppose you had selected the 100-volt range, but the actual voltage was 109.6. Without over-range, the display would signal over-range and you would be forced to go to the 1000-volt range for a reading. On that scale, even if the accuracy were perfect, the reading could be only 109. That doesn't sound like much inaccuracy, but there's more.

With any DMM or frequency counter, there is always a question about the reading of the least-significant digit (the one on the right). That's because square-waves are used and there is a chance one was not at the rising or falling edge when the count was started or stopped. The last digit, then, has a



The B&K Precision Model 282 DMM has the ranges most needed for testing home-entertainment electronic products. Some of the features are a 3-1/2-digit Sperry display, auto-polarity, and shielded test leads.

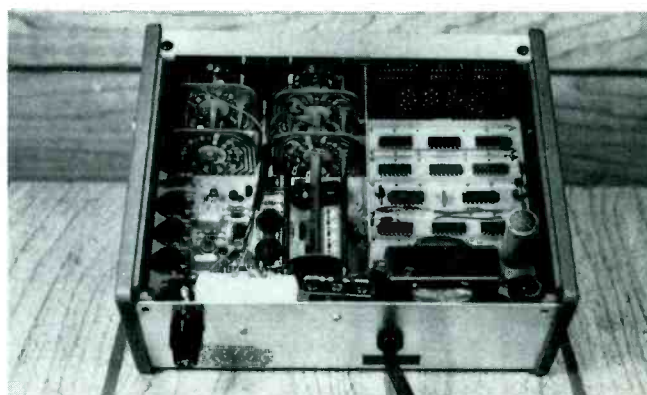

This inside view of the B&K Model 282 shows the neat and uncluttered arrangement of the components. Of course, it is all-solid-state.

good chance of being wrong by one number. This is why some meters have a "bobble," which is the changing from one number to another although the input signal is steady.

DMM's also suffer from decreased accuracy at the low end of each range, just as VOM's or VTVM's do. Taking all these considerations into account, the reading of 109.6 obtained on the 100-volt range might be 105 or 113 when measured on the 1000-volt range. For these reasons, you should select the lowest range that does not activate the over-range indication.

The 1/2 digit also gives the effect of doubling the number of ranges available, but without the additional cost, and without the inconvenience of being forced to select the next higher range for a reading only slightly above the range. For example, the 1-volt range reads up to 1.999 volts, the 10 volt up to 19.99, the 100 volt up to 199.9 and the 1000 volt up to 1999 volts.

#### AC frequency response

One subject seldom mentioned about meters is the frequency response of the AC voltage measurements. Some don't have flat bandwidth. The B&K Model 282 passed that test with flying colors. In fact, it was necessary to measure the output of an audio oscillator by using four different meters before any discrepancy could be proved. Frequency response of our sample was -1 dB at 20 Hz and -1 dB at 20,000 Hz on the 1-volt range, certainly more than ample for all power and audio measurements.

AC voltage measurements are direct reading in RMS calibration for sine waves. There is no easy formula to change these to p-p.

#### Speed of reading

The pointer of an analog meter swings up to the reading, but does not stop there; it overshoots, undershoots and continues to oscillate in lesser amounts until it finally comes to rest. DMM's can't overshoot because there are no mechanical movements, but the readings are not instantaneous. Some time is

required for the circuit to sample and arrive at a final reading. The B&K 282 often goes "blink" once with a partial reading before it flashes on with the final one. The total time is perhaps a second or so, about the amount of time required for a person's eyes to scan from the point of testing to the meter readout. When the probes are removed, the reading goes to zero in several steps.

#### Input impedance

The input impedances for both DC and AC voltage functions are 10 megohms. The value for DC is nearly the same as for most VTVM's, but the AC value is much higher. Typically, VTVM's have lower than 1-megohm input impedance.

During AC and DC current measurements, the test leads are shunted by low value resistances, so the voltage drop is 100 millivolts at full reading for DC, and 100 millivolts RMS for AC.

#### Ohmmeter characteristics

Six ohmmeter ranges are provided to measure resistances between .1 ohm and 19.99 megohms. The 100-ohm range is direct reading in **ohms**, the 1K, 10K, 100K and 1000K ranges are direct reading in **thousands (K)**, and the 10M range is direct reading in **megohms**.

When no resistor is connected to the probes, about 15 volts can be measured at the probes, with the "ground" wire positive and the shielded wire negative.

There is no danger to solid-state devices, although the ohmmeter voltage is ten times that of most VTVM's. The reason is that the

circuit uses a constant current. Therefore, any resistance that does not activate the over-range indication applies less than 2 volts to the test probes. For example, a 178.2-ohm resistor had 1.8 volts across it on the 100-ohm range.

#### Controls

One knob selects the basic function (DC volts, ohms, etc.) and another selects the range (10 volts, 100 ohms, etc.).

No selection of polarity is necessary on DC volts and DC current because of the automatic-polarity feature. A minus sign on the left of the digits lights when the polarity is negative. When the voltage or current is positive, the minus sign is not lighted, indicating positive by inference.

Between the two large knobs is a small one marked "Zero." In practice, you select the function and range you want, short together the test probes and adjust the Zero knob for all zeros on the display.

With our sample, the knob really wasn't needed on DC volts, AC volts, or ohms. Drift over a period of several hours was only about one number change of the least-significant digit. Setting of the Zero knob was not critical because it has a vernier action over several complete revolutions. I obtained good results by stopping the adjustment midway between where the minus sign was lighted and where the least-significant digit changed to a one.

Adjustment of the Range switch positions the decimal point the same for all settings of the Function switch.



Read-out of 3-1/2 digits plus stable and accurate circuitry shows this resistor to be 152.2 ohms, not 150 or 160 ohms.

new!  
**FINCO**<sup>®</sup>  
 '80 Series  
 COLOR SPECTRUM™  
 TV/FM ANTENNAS

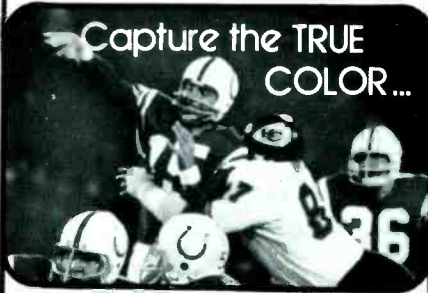

Capture the TRUE  
 COLOR...

VHF-UHF-FM

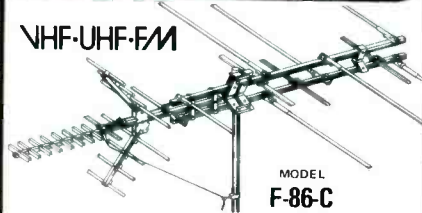

MODEL  
**F-86-C**

- MODEL F-89-C  
 54 Elements VHF-UHF-FM  
 CX-F-89-C (75 OHM)
- MODEL F-88-C  
 47 Elements VHF-UHF-FM  
 CX-F-88-C (75 OHM)
- MODEL F-87-C  
 33 Elements VHF-UHF-FM  
 CX-F-87-C (75 OHM)
- MODEL F-86-C  
 27 Elements VHF-UHF-FM  
 CX-F-86-C (75 OHM)
- MODEL F-85-C  
 21 Elements VHF-UHF-FM  
 CX-F-85-C (75 OHM)

VHF-FM

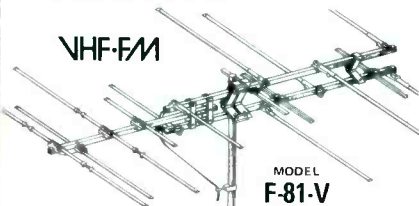

MODEL  
**F-81-V**

- MODEL F-84-V  
 34 Elements VHF-FM  
 CX-F-84-V (75 OHM)
- MODEL F-83-V  
 28 Elements VHF-FM  
 CX-F-83-V (75 OHM)
- MODEL F-82-V  
 20 Elements VHF-FM  
 CX-F-82-V (75 OHM)
- MODEL F-81-V  
 14 Elements VHF-FM  
 CX-F-81-V (75 OHM)

Write for Catalog No. 20-658, Dept. LS-9-74

**The FINNEY Co.**  
 34 West Interstate Street  
 Bedford, Ohio 44146

**Test Probes**

One of my pet peeves with most other digital meters is the lack of shielded test leads, which are especially needed around the horizontal section of TV receivers. Although banana jacks are used on the panel of the Model 282, B&K has taken care of the problem very neatly by shielding the "hot" probe and connecting the shielding to the other wire through moulded insulation at the plug ends.

In addition, a 100K resistor inside the "hot" probe can be switched in or out as desired for isolation of RF or other sensitive signals.

Three banana jacks are provided for test leads. The third one is used only on the 1000-milliampere (1-A) ranges of AC and DC current. Therefore, for all practical purposes it is not necessary to change position of the plugs of the test prods.

**Accuracy**

Because I have no precise, laboratory standard meters, I could not test the accuracy of the B&K Model 282 DMM. A factory calibration sheet packed with the meter showed +1.000 VDC as +.999, 1.000 VAC as .997, 10.00K ohms as 10.00K ohms, 10.00 megohms as 9.92 megohms, and +1.000 amperes DC as +1.000 amperes. Comparisons with several analog meters gave me no reason to question the factory specifications.

Accuracy is best on the first four DC voltage ranges ( $\pm 5\%$  of reading,  $\pm 1$  digit), and is least precise on the 1000-milliampere AC-current range ( $\pm 1.5\%$  of reading,  $\pm 1$  digit). Other ranges fall between those extremes.

**Interpreting the readout**

On all four ranges of both DC and AC volts, the digital display reads directly in **volts**. The limits are .001 volt and 1,999 volts.

On all four ranges of both DC and AC current, the display reads directly in **milliamperes**. The limits are .001 milliampere and 1,999 milliamperes.

The 100-ohms range gives direct readings in **ohms**. The 1K, 10K, 100K and 1000K ranges give direct readings in **thousands of ohms**. In other words, just take the reading,

decimals and all, and add "K" after it. The 10-megohm range is direct reading in **megohms**. A 5.6-megohm resistor might read 5.47 plus "M."

If more than twice the **rated** value of voltage, current, or resistance is applied to any range, the half-digit will be lighted, but the other three digits will be blanked out. This is the over-range indication. For example, more than 2.000 volts applied to the 1-volt range, or higher than 2,000 ohms applied to the 1K resistance range will activate the over-range signal.

To obtain best reading resolution as well as absolute accuracy, use the **highest** range that does not activate the over-range indication.

For example, an ordinary "D" cell might read +1.556 on the 1-volt range, but probably would read +2 volts on the 1000-volt range.

If you switch in the 100K resistor at the tip of the probe, all DC voltage readings will be 1% low. Make allowances for that, if extreme accuracy is necessary. Don't use the resistor on **any** other functions.

**Miscellaneous**

An adjustable carrying handle doubles as a stand to tilt the front of the instrument, although, of course, the angle at which you read the display has no effect on the accuracy.

The Sperry read-out has numbers that are slightly more than 1/2" high. Such a size doesn't sound impressive until you realize that the numbers on a large-scale VTVM are only slightly larger than 1/16 inch. In practice, the display can be read from across a very large room! And the red color makes the digits very readable.

Voltage functions are protected internally by diodes and a series resistance, current ranges have fuse and diode protection, and ohms functions are protected up to +100 volts or more, depending on range.

The B&K Model 282 DMM is 3-1/2" X 7" X 9", weighs 5 pounds and requires only 15 watts of 120 VAC power, making it an excellent instrument for use both on service calls as well as for bench uses.

I found it accurate and convenient to use. □

For More Details Circle (11) on Reply Card

# Now, 23v black matrix in an economy line.

From Sylvania, of course.

Replacing a black-matrix tube has usually meant buying a brand new tube because rebuilds just didn't exist. Now, Sylvania has changed all that.

We've added five black-matrix tube types to our low-cost Color Screen 85 line, and that even includes the popular 23-inch diagonal size.

That means you can offer your customers two different price ranges.

And increase sales opportunities by offering a low-price replacement.

With Sylvania, you not only have one of the broadest lines of replacement tubes in the industry.

You also have the latest.

**Electronic Components Group,  
GTE Sylvania, 100 First Ave.,  
Waltham, Mass. 02154.**



**GTE SYLVANIA**

# Getting started servicing electronic medical equipment

By Joseph J. Carr, CET



*Although the number of electronic devices used in the practice of medicine is growing rapidly, it has been difficult for a TV technician to get a toe-hold in the servicing of such equipment. The author successfully made the change, and tells you how to get started.*

In past issues of ELECTRONIC SERVICING, I've described some of the typical circuits used in medical electronic equipment. This information was presented to increase your knowledge of an unusual electronic field, and to give you enough practical data so you could decide whether or not to start servicing such equipment.

Several readers have reported how difficult it is to be accepted in the field. One reader even took us to task for making this kind of servicing appear too easy. He viewed it as a vocation requiring training and certification.

The wide variety of local conditions makes it impossible for me to tell you exactly how to start and operate a medical-service business. However, as a servicer with in-hospital experience, I can pass on to you some valuable facts about hospital contacts. It's essential that

you know who is in a position to authorize service, how much typically is being paid, and who does the service at the present time.

Also of extreme importance are the complex relationships within the medical organizations, and what they, as consumers of your product, expect from you.

## Monetary Considerations

Specialized electronic medical equipment, because of the high-quality construction and rigid specifications, costs the user a lot of money, even for equipment in small packages. Therefore, prices for servicing such merchandise are much higher than for TV repairs.

In return for premium prices, however, the medical profession expects and demands a higher level of servicing ability. To be brutally frank, there are some TV shops whose knowledge, test equipment, and standards of workmanship are not adequate for medical work. Society generally does not allow doctors and other medical professionals any margin for error. Defective electronic devices have been a large factor in some malpractice suits, so you can understand the caution.

## Service calls

Service calls at one major university-affiliated medical center last year averaged \$156, or \$88 labor and \$68 for parts. Such prices are fairly typical for metropolitan areas. Rural hospitals often pay even more.

A reader living in a western state recently informed me that his local hospital is forced to have a manufacturer's representative flown in

even for simple repair jobs. This type of service is "portal-to-portal" in which the customer pays for the man's time in transit, the plane ticket, freight on parts and any motel or hotel accommodations that are necessary. Even when a conscientious technician splits the travel time between two jobs, the bill can be huge.

These hourly labor charges, which apply whether the rep is servicing the equipment or sipping cocktails on a plane, range from \$20 per hour for the simpler, more common, equipment up to \$75 per hour for extremely-complex systems.

Yes, the requirements on a technician are very high, but the rewards are in proportion.

## Service In Hospitals

The quality of service repairs in any one hospital might range from haphazard and incompetent to extremely good. Typically, service is provided by any or all of the following sources or departments:

- an in-house biomedical electronics lab;
- service representatives of the equipment manufacturers;
- local shops affiliated with a local manufacturer;
- non-affiliated shops;
- the hospital electrician; or
- the hospital general-maintenance man.

If a hospital predominantly depends on the latter two categories, it's certain they are in trouble! I don't mean to insult those fellows; probably they are most competent in their own field. But what qualifies them to repair a multiple-beam scope, or other kinds of electronic equipment?



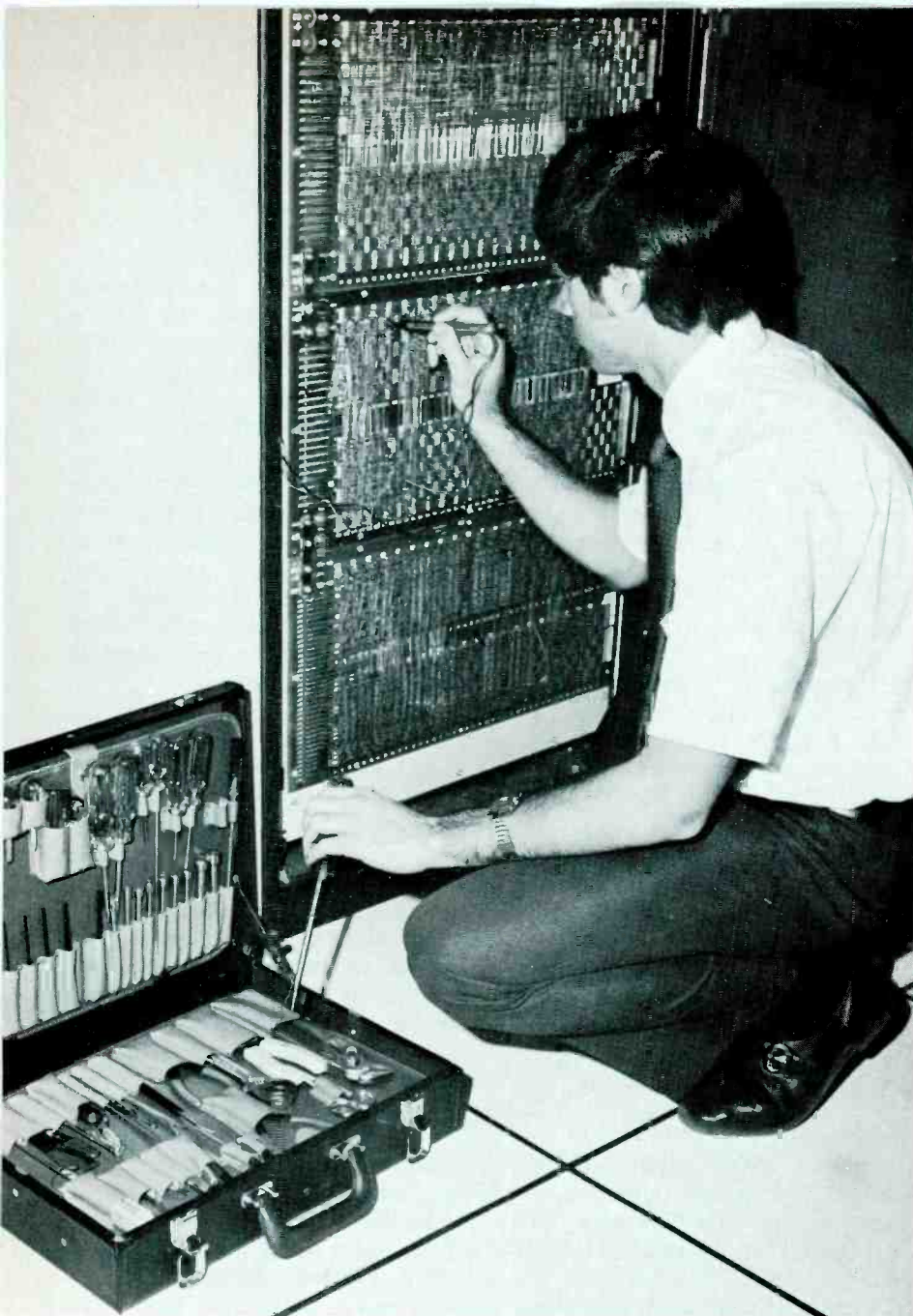

Fig. 1 A medical field-service technician should be well-groomed, and have adequate portable test equipment and tools. (Courtesy of Jensen Tools and Alloys)

#### Supplementing service

Even those hospitals which have in-house capability often are potential customers for service. In the first place, many such labs are understaffed and need outside help. When you supplement their service, most often you would report to the biomedical engineer. Or you might offer 24-hour emergency service, which their lab is not prepared to do.

In other cases, some hospital departments will refuse to use the in-house lab. Does that fact surprise you? A huge medical complex might look monolithic from the

outside, while actually being as fragmented as Europe in the dark ages. In such situations, you can make inroads.

#### Who to contact

First, you should make an appointment with the head of purchasing, although he might or might not make decisions about service. Call for the appointment, but don't try to "sell" by telephone. It's too easy to say "No" that way. And besides, he just might want to see what you look like.

The head of purchasing might buy all service, some service, or

### Table 1

#### List Of Test Equipment

##### Field

pocket VOM  
portable scope  
ECG waveform simulator  
defibrillator tester  
microampere meter  
(leakage tester)

##### Shop

all on the field list  
VTVM, digital, or FET meter  
transistor tester  
tube tester  
function generator  
(sine, square & triangle waveforms of .01 Hz to 100 KHz)  
frequency/period digital counter (frequency to 10 MHz or higher, period to .1 mS, gate durations of .1, 1, and 10 seconds)  
audio VTVM  
assorted power supplies  
scope with bandwidth to 10 MHz (preferably with storage or external-camera capability)

### Table 2

#### Recommended Spare Parts

**For tape or paper drive machines** (ECG, chart recorders, tape memory units, etc.):

rubber rollers  
bearings  
belts and drive chains

#### For ECG machines:

analog stylus' or pens  
marker stylus' or pens

#### For defibrillators:

HV rectifiers,  
diode and vacuum tube  
switches and relays

#### General:

one or more of each  
PC board used assortment  
of degreaser, cleaners,  
cement, cooling spray  
and other chemicals

none of it, depending on the particular hospital. Even if he buys no service, his department processes the paper work that makes your payment possible. Therefore, he will know who can authorize service.

In some hospitals, it might be necessary to call on and sell any or all of the following personnel:

- the administrator, or his assistants;
- the doctor heading the department which owns the equipment;
- a head nurse or nursing supervisor of the department;
- director of nursing;
- chief medical or surgical officer;
- unit manager;
- head unit manager;
- biomedical engineer; or
- director of plant operations.

### Reputations

Doctors and the assisting para-professionals tend to be close-knit. One implication is that word of reputations (both good and bad) travels rapidly. Even where the top administrations are aloof from each other, the lower ranks can be in close contact. One fact of hospital life is that many professional-level specialists often play "musical hospitals" by swapping places of employment every couple of years.

### 24-Hour Service

Instant drop-everything service is necessary on life-saving or monitoring equipment. Either you must be "open" or "on call" 24 hours a day, with no exceptions. At a minimum this requirement means an answering service, and some kind of paging receiver to be carried when you are away from phones.

If you hire a technician for 24-hour service, it is accepted procedure to pay him a percentage of his hourly wage (or a fixed fee) for being on call, plus his regular hourly wage when he actually is required to make a service call.

### Components

A technician must be reasonably independent of the home-base shop for both parts and test instruments, especially if he is expected to cover a wide geographical area. A TV

outside man sometimes can stop at a friendly competitor and have him grant the courtesy of selling a tube or component at less than retail. The medical service technician, by comparison, might be the entire "trade" in that area.

Inventories sometimes include entire devices, which place the customer back in business instantly. That gives you time to hide in a utility room, or other out-of-the-way area, while you repair the defective instrument.

Of course, it's not practical to stock complete machines unless you service just a few kinds, or the line of just one manufacturer.

Do your best to stock parts. You might be able to put off a TV or stereo customer with the well-worn "awaiting parts" story. But to a cardiologist or a Coronary-Care-Unit charge nurse, that's the most incompetent, least-excusable answer you can give! It is one of the reasons a servicer can acquire a swiftly-moving bad reputation.

### Critical areas

Areas in which continuous 24-hour-per-day service might be required include the Coronary-Care Unit (CCU), Intensive-Care Unit (ICU), Special-Care Unit (SCU), Emergency Room (ER), Operating Rooms (OR), anesthesia departments, and respiratory-therapy departments.

This latter department often bears responsibility for the emergency equipment, including monitoring scopes and defibrillators, which are used anywhere in the hospital that a cardiac arrest occurs.

For this reason, you can expect the chief respiratory therapist or his doctor boss to be far less than enthusiastic about any firm which brags about, but cannot deliver, rapid emergency service. Their needs are so acute that such departments often have the authority to bypass normal channels for procurement of service. That can work to your advantage because it's only necessary to contact and please a few people.

### Costly Down-Time

Equipment of the laboratory and radiology departments costs a great deal of wasted money when it doesn't work. However, much of the equipment is very complex, and it is better to leave all but the most elementary repairs to the factory man, lest you "get egg on your face" from a heroic, but useless, attempt at service. This is not to say the circuits are "above" you, but they are much too complex to be serviced without factory manuals, which are often considered to be proprietary secrets.

### Convenience Equipment

In some departments, the electronic equipment makes a surgeon's work easier. Some devices of this kind are the RF generators used instead of a scalpel to cut tissues, and cauterize bleeders (cut veins). Naturally, the surgeon could use scalpels and sutures, but he would be upset by loss of the convenience, and recommend the company which could deliver rapid and competent service, when needed.

### Technician Qualifications

Any man servicing biomedical equipment **must** be a professional, or he and his company will be out of the game in a hurry. He must understand both the older vacuum-tube equipment, and the most-modern of solid-state devices. He must know a bit about digital electronics, analog electronics and measurement methods. This includes familiarity with chart recorders, high-gain DC amplifiers, transducers, Wheatstone bridges, and other non-TV equipment. Also, he should not balk at working on electro-mechanical devices.

It is not necessary that he be a tech-school graduate, although this is good. Some larger institutions ask for resume's (called "Curriculum Vitae", if the hospital is university affiliated) on each man who will be doing the servicing.

The personal appearance of the man must be appropriate. He should not appear to be a maintenance man. In many places, he is

*(Continued on page 36)*

## cartoon corner



"I LOVE MY WORK. IT'S THE BILL PRESENTATION PART I DETEST."



"TWO BITS SAYS IT'S A TUNER JOB."



"I COULDN'T AFFORD PARTS AND LABOR, SO I JUST TOOK THE PARTS."

### ELECTRONIC SERVICING is your magazine!

If you would like to see an article about a particular subject directly related to servicing consumer or communications electronic products, send us your suggestion.

# HOW TO RESTORE TV TUNERS



DIRTY, CORRODED OR GUNKED-UP TUNER CONTACTS MEAN SNOWY PICTURES.

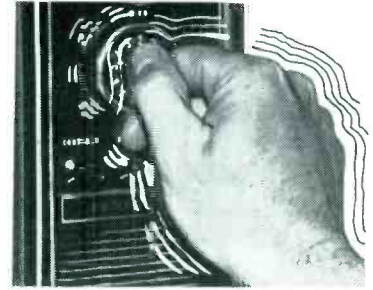

IF YOU HAVE TO WIGGLE THE CHANNEL SELECTOR TO IMPROVE PICTURE QUALITY, CONTACTS ARE DEFINITELY POOR.

Now a brand new product solves these problems

# TUN-O-POWER RESTORES TUNERS!

Just spray TUN-O-POWER on tuner contacts and rotate the tuner. Within 5 seconds, contacts will be clean and shiny. Detent action will be smooth as silk. Most important, you'll get sharp pictures on all channels, without wiggling knobs.

TUN-O-POWER works so well, (even on the worst tuners) it's hard to believe. Unless you try it yourself.

Offer to restore the tuner of every set you service— for an extra charge of \$5.00 or more, depending on how hard it is to get at the tuner. Your customer will appreciate the extra service because the set will work like new. You'll improve your reputation as well as your profit margin.

Only TUN-O-POWER restores TV tuners. Try it... you'll love it!

**CHEMTRONICS**  
INCORPORATED

1260 RALPH AVE., BROOKLYN, N.Y. 11236

Our business is improving yours.



For More Details Circle (27) on Reply Card

(Continued from page 34)

considered a field engineer, or he is not considered at all. Slacks, shirt, and tie are universally necessary. Also advisable is a name tag, one of the plastic engraved kinds, with his name, company name, and title.

A few hospitals require a technician to wear a white lab-type coat with his name, company, and title embroidered over the left breast pocket if he services equipment in patients' rooms. This is not a matter of "playing doctor", but a question of identification. There is something about strangers in street clothing going in and out of patient rooms that makes some people nervous.

Expect to continuously upgrade your knowledge and skills. Some of the most-honored manufacturers of electronic equipment supply machines for the medical market. Age of the units range from old vacuum-tube models to the latest ones with LED readouts and both analog and digital circuitry.

It's a help if you understand something of medical terminology. How can you expect to service a pH meter if you don't know what the letters stand for?

A really-good servicer must be technically competent and have the ability and personality to get along well with the staff.

One more attribute is essential: diplomacy. When medical equipment breaks down, there might be danger to patients, or at least the failure causes irritating inconvenience. Nerves sometimes get on edge, and the people must not be handled abrasively. Also, many of the service problems might be due to operator negligence or error. Don't ever "tell them what you think of them." It might be years before you again sell any service to that hospital!

### Equipment Needed

Although your specific equipment needs will depend on the instruments you intend to service, we can offer some general recommendations. For example, Table 1 lists the test equipment most often specified by manufacturers of medical equipment.

A generous assortment of hand-

tools will be needed. Most field-service people prefer the attache-case type, as shown in Figure 1.

The tool case should include a pocket-sized VOM. I prefer a VOM over a VTVM because of the AC power problem. And the batteries of the FET type seem to go bad at inopportune moments.

A portable oscilloscope is a necessity. Chances are you'll find it nearly impossible to park near a hospital, so make sure your scope and tool case are as light as possible. Dual-beam and triggered sweep are almost mandatory. Vertical bandwidth up to 500 kHz will be satisfactory in most cases. However, if you can, get one flat to 10 MHz.

Another useful instrument is the ECG waveform simulator, sometimes humorously called the "chicken heart." These devices generate a 1 millivolt waveform that closely resembles that of the normal human ECG. I prefer the Parke-Davis Model 3150, because it is small enough to fit into a tool case or lab coat pocket. This is a personal preference based only on the two or three models I know about.

### Certification Of Technicians

The trend towards certification abounds in the medical world. Everyone else from the ECG technician on up to the most senior medical specialist must be certified, registered, licensed, or bottled-in-the-bond 100-proof; so why not the electronics man?

Currently, there are sources of certification from two organizations. It might be wise to gain certification from both, "just in case." The two are:

International Society of  
Electronics Technicians  
(ISCET)  
1715 Expo Lane  
Indianapolis, Indiana 46224

and

Association For the Advancement  
of Medical Instrumentation  
(AAMI)  
Suite 417  
1500 Wilson Boulevard  
Arlington, Virginia 22209

The latter organization issues certification for "Biomedical Equipment Technician" (BMET).

Malpractice suits appear to be the modern national pastime, so expect your client hospitals to ask that you be certified. Otherwise, they would be liable if a piece of equipment injured a patient, and the legal people asked if the tech was qualified.

### Payment For Service

Be sure you ask the purchasing department of each institution about requirements; failure to observe the rules can result in loss of your payment or extra delay in addition to the slow payment that is sometimes the case. Most require the use of a purchase order (PO); some before work is started, and others within one working day after the work is performed. Expect to bill; medical repair service is never COD.

### Miscellaneous Tips

Don't allow your technical capability to be overextended. If you must start small (the usual way), try to specialize in a single brand of equipment. Or at least restrict the number of brands. Make a survey of your market (go see prospects) to find out what kind of equipment is in use. Don't promise anything you can't deliver!

Locate the people who sell equipment to hospitals. They might be manufacturer's representatives or independent salesmen, or even at a medical-supplies wholesale house. In any event, it's likely they will view service as a necessary but troublesome evil they would gladly allow some competent local firm to handle.

### Conclusion

These are the facts you need to begin a business of servicing medical electronic equipment. It's not an easy field to enter, but the rewards are more than adequate to offset the problems. □



# SIGNATURE PATTERNS

Made On Sprague/Jud Williams Model A Curve Tracer

## MAGNAVOX CHASSIS T989

MANUFACTURER		MODEL OR CHASSIS	
TRANSISTOR IDENTIFICATION & CURVE TRACER SETTINGS MAGNAVOX		SIGNATURE PATTERNS T989	
TRANSISTOR IDENTIFICATION & CURVE TRACER SETTINGS MAGNAVOX		SIGNATURE PATTERNS T989	
Q1 1ST IF A PANEL			
<b>POLARITY</b>	NPN		
<b>SWEEP VOLTAGE</b>	30V		
<b>BASE CURRENT</b>	500 $\mu$ A		
Q2 2ND IF A PANEL			
<b>POLARITY</b>	NPN		
<b>SWEEP VOLTAGE</b>	30V		
<b>BASE CURRENT</b>	50 $\mu$ A		
Q3 3RD IF A PANEL			
<b>POLARITY</b>	NPN		
<b>SWEEP VOLTAGE</b>	30V		
<b>BASE CURRENT</b>	200 $\mu$ A		
Q4 VIDEO DRIVER A PANEL			
<b>POLARITY</b>	PNP		
<b>SWEEP VOLTAGE</b>	30V		
<b>BASE CURRENT</b>	50 $\mu$ A		
Q5 AUX IF AMP A PANEL			
<b>POLARITY</b>	NPN		
<b>SWEEP VOLTAGE</b>	30V		
<b>BASE CURRENT</b>	500 $\mu$ A		
Q6 AFT AMP A PANEL			
<b>POLARITY</b>	NPN		
<b>SWEEP VOLTAGE</b>	30V		
<b>BASE CURRENT</b>	10 $\mu$ A		
Q1 NOISE CANC B PANEL			
<b>POLARITY</b>	PNP		
<b>SWEEP VOLTAGE</b>	30V		
<b>BASE CURRENT</b>	50 $\mu$ A		
Q2 AGC KEYER B PANEL			
<b>POLARITY</b>	PNP		
<b>SWEEP VOLTAGE</b>	30V		
<b>BASE CURRENT</b>	20 $\mu$ A		
Q3 IF AGC BUFFER B PANEL			
<b>POLARITY</b>	NPN		
<b>SWEEP VOLTAGE</b>	30V		
<b>BASE CURRENT</b>	10 $\mu$ A		
Q4 RF AGC INV B PANEL			
<b>POLARITY</b>	NPN		
<b>SWEEP VOLTAGE</b>	30V		
<b>BASE CURRENT</b>	50 $\mu$ A		

MANUFACTURER	MODEL OR CHASSIS
TRANSISTOR IDENTIFICATION & CURVE TRACER SETTINGS MAGNAVOX	SIGNATURE PATTERNS T989

Q5 1ST VIDEO DRIVER B PANEL	
<b>POLARITY</b> PNP	
<b>SWEEP VOLTAGE</b> 30V	
<b>BASE CURRENT</b> 10 $\mu$ A	

Q6 VIDEO AMP B PANEL	
<b>POLARITY</b> PNP	
<b>SWEEP VOLTAGE</b> 30V	
<b>BASE CURRENT</b> 100 $\mu$ A	

Q7 BEAM LIMITER B PANEL	
<b>POLARITY</b> PNP	
<b>SWEEP VOLTAGE</b> 30V	
<b>BASE CURRENT</b> 1000 $\mu$ A	

Q8 BLANKING DRIVER B PANEL	
<b>POLARITY</b> NPN	
<b>SWEEP VOLTAGE</b> 30V	
<b>BASE CURRENT</b> 200 $\mu$ A	

Q9 2ND VIDEO DRIVER B PANEL	
<b>POLARITY</b> PNP	
<b>SWEEP VOLTAGE</b> 30V	
<b>BASE CURRENT</b> 200 $\mu$ A	

Q10 VERT BLANKING INV B PANEL	
<b>POLARITY</b> NPN	
<b>SWEEP VOLTAGE</b> 30V	
<b>BASE CURRENT</b> 10 $\mu$ A	

MANUFACTURER	MODEL OR CHASSIS
TRANSISTOR IDENTIFICATION & CURVE TRACER SETTINGS MAGNAVOX	SIGNATURE PATTERNS T989

Q1 CHROMA AMP C PANEL	
<b>POLARITY</b> NPN	
<b>SWEEP VOLTAGE</b> 30V	
<b>BASE CURRENT</b> 200 $\mu$ A	

Q2 BANDPASS AMP C PANEL	
<b>POLARITY</b> NPN	
<b>SWEEP VOLTAGE</b> 30V	
<b>BASE CURRENT</b> 50 $\mu$ A	

Q3 BURST AMP C PANEL	
<b>POLARITY</b> NPN	
<b>SWEEP VOLTAGE</b> 30V	
<b>BASE CURRENT</b> 1000 $\mu$ A	

Q4 KILLER/ACC AMP C PANEL	
<b>POLARITY</b> NPN	
<b>SWEEP VOLTAGE</b> 30V	
<b>BASE CURRENT</b> 20 $\mu$ A	

Q5 ACC DRIVER C PANEL	
<b>POLARITY</b> NPN	
<b>SWEEP VOLTAGE</b> 30V	
<b>BASE CURRENT</b> 20 $\mu$ A	

Q6 KILLER AMP C PANEL	
<b>POLARITY</b> PNP	
<b>SWEEP VOLTAGE</b> 30V	
<b>BASE CURRENT</b> 50 $\mu$ A	

MANUFACTURER	MODEL OR CHASSIS
TRANSISTOR IDENTIFICATION & CURVE TRACER SETTINGS MAGNAVOX	SIGNATURE PATTERNS T989

Q7 3.58 OSC C PANEL	
<b>POLARITY</b> NPN	
<b>SWEEP VOLTAGE</b> 30V	
<b>BASE CURRENT</b> 50μA	

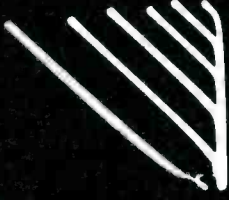
Q8 3.58 BUFFER C PANEL	
<b>POLARITY</b> PNP	
<b>SWEEP VOLTAGE</b> 30V	
<b>BASE CURRENT</b> 500μA	

Q9 3.58 AMP C PANEL	
<b>POLARITY</b> PNP	
<b>SWEEP VOLTAGE</b> 30V	
<b>BASE CURRENT</b> 50μA	

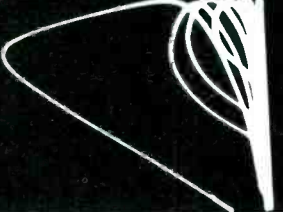
Q1 VERT OUTPUT D PANEL	
<b>POLARITY</b> PNP	
<b>SWEEP VOLTAGE</b> 30V	
<b>BASE CURRENT</b> 200μA	

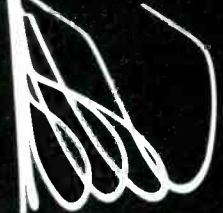
Q2 VERT OUTPUT D PANEL	
<b>POLARITY</b> NPN	
<b>SWEEP VOLTAGE</b> 30V	
<b>BASE CURRENT</b> 200μA	

Q3 HORIZ PINCUSHION D PANEL	
<b>POLARITY</b> NPN	
<b>SWEEP VOLTAGE</b> 30V	
<b>BASE CURRENT</b> 1000μA	

MANUFACTURER	MODEL OR CHASSIS
TRANSISTOR IDENTIFICATION & CURVE TRACER SETTINGS MAGNAVOX	SIGNATURE PATTERNS T989

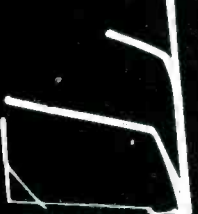
Q4 SYNC SEP D PANEL	
<b>POLARITY</b> PNP	
<b>SWEEP VOLTAGE</b> 30V	
<b>BASE CURRENT</b> 10μA	

Q5 PHASE SPLITTER D PANEL	
<b>POLARITY</b> NPN	
<b>SWEEP VOLTAGE</b> 30V	
<b>BASE CURRENT</b> 50μA	

Q7 REACTANCE D PANEL	
<b>POLARITY</b> NPN	
<b>SWEEP VOLTAGE</b> 30V	
<b>BASE CURRENT</b> 10μA	

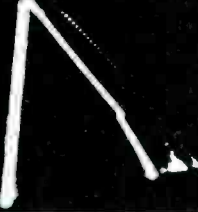
Q8 HORIZ OSC D PANEL	
<b>POLARITY</b> NPN	
<b>SWEEP VOLTAGE</b> 30V	
<b>BASE CURRENT</b> 500μA	

Q9 HORIZ DRIVER D PANEL	
<b>POLARITY</b> NPN	
<b>SWEEP VOLTAGE</b> 30V	
<b>BASE CURRENT</b> 500μA	

Q10 PINCUSHION DRIVER D PANEL	
<b>POLARITY</b> NPN	
<b>SWEEP VOLTAGE</b> 30V	
<b>BASE CURRENT</b> 50μA	

MANUFACTURER	MODEL OR CHASSIS
TRANSISTOR IDENTIFICATION & CURVE TRACER SETTINGS MAGNAVOX	SIGNATURE PATTERNS T989

MANUFACTURER	MODEL OR CHASSIS
TRANSISTOR IDENTIFICATION & CURVE TRACER SETTINGS MAGNAVOX	SIGNATURE PATTERNS T989

Q11 HV LIMITER D PANEL	
<b>POLARITY</b> NPN INVERTED	
<b>SWEEP VOLTAGE</b> 30V	
<b>BASE CURRENT</b> 500 $\mu$ A	

Q3 VERT SWITCH MID VERT OSC MODULE	
<b>POLARITY</b> NPN	
<b>SWEEP VOLTAGE</b> 30V	
<b>BASE CURRENT</b> OPEN BASE	

Q1 SIDE PIN SHAPER REGULATOR MODULE	
<b>POLARITY</b> NPN	
<b>SWEEP VOLTAGE</b> 30V	
<b>BASE CURRENT</b> 10 $\mu$ A	

Q4 VERT AMP MID VERT OSC MODULE	
<b>POLARITY</b> NPN	
<b>SWEEP VOLTAGE</b> 30V	
<b>BASE CURRENT</b> 10 $\mu$ A	

Q2 REGULATOR DRIVER REGULATOR MODULE	
<b>POLARITY</b> NPN	
<b>SWEEP VOLTAGE</b> 30V	
<b>BASE CURRENT</b> 10 $\mu$ A	

Q5 PIN ADDER MID VERT OSC MODULE	
<b>POLARITY</b> NPN	
<b>SWEEP VOLTAGE</b> 30V	
<b>BASE CURRENT</b> 200 $\mu$ A	

Q3 CONSTANT CURRENT REGULATOR MODULE	
<b>POLARITY</b> PNP	
<b>SWEEP VOLTAGE</b> 30V	
<b>BASE CURRENT</b> 20 $\mu$ A	

Q6 VERTICAL DRIVER MID VERT OSC MODULE	
<b>POLARITY</b> PNP	
<b>SWEEP VOLTAGE</b> 30V	
<b>BASE CURRENT</b> 500 $\mu$ A	

Q1 VERT OSC MED VERT OSC MODULE	
<b>POLARITY</b> PNP	
<b>SWEEP VOLTAGE</b> 30V	
<b>BASE CURRENT</b> 20 $\mu$ A	

Q1 VIDEOMATIC MODULE	
<b>POLARITY</b> PNP	
<b>SWEEP VOLTAGE</b> 30V	
<b>BASE CURRENT</b> 20 $\mu$ A	

Q2 VERT OSC MID VERT OSC MODULE	
<b>POLARITY</b> NPN	
<b>SWEEP VOLTAGE</b> 30V	
<b>BASE CURRENT</b> 20 $\mu$ A	

Q1 VIDEO OUTPUT MODULE	
<b>POLARITY</b> NPN	
<b>SWEEP VOLTAGE</b> 30V	
<b>BASE CURRENT</b> 20 $\mu$ A	

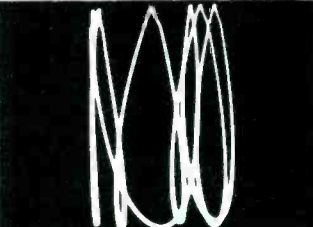

MANUFACTURER	MODEL OR CHASSIS
TRANSISTOR IDENTIFICATION & CURVE TRACER SETTINGS MAGNAVOX	SIGNATURE PATTERNS T989

Q201 REGULATOR		
POLARITY		NPN
SWEEP VOLTAGE		30V
BASE CURRENT		100 $\mu$ A

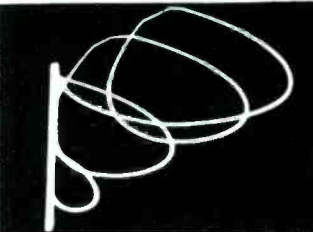
Q302 HORIZ OUTPUT		
POLARITY		NPN
SWEEP VOLTAGE		30V
BASE CURRENT		500 $\mu$ A



## New goodies add measure power to Fluke 8000A

Best selling 3½ digit DMM even better with new options and accessories

New ac/dc high current option lets you measure 10 A. continuously or up to 20 A. momentarily. New low 2 and 20  $\Omega$  scales give 0.001  $\Omega$  resolution. Low cost RF probe offers new capability.

Other options include rechargeable battery pack, digital printer output, deluxe test leads, 40 kV high voltage probe, 600 A. ac current probe, carrying cases, dust cover and rack mount.

Basic "best buy" \$299 DMM feature dc accuracy of 0.1%. Measure ac/dc volts from 100  $\mu$ v to 1200 v, current from 100 nanoamperes to 2 A. and resistance from 100 milliohms to 20 megohms. Guaranteed 20,000 hour MTBF.



John Fluke Mfg. Co., Inc., P.O. Box 7428, Seattle, WA 98133

For data out today, dial our toll-free hotline, 800-426-0361

For More Information Circle (12) on Reply Card  
For Demonstration Circle (25) on Reply Card

# MAGIC COLOR ANTENNAS Sales Orbit

THROUGH:

- ★ Higher Profit
- ★ Sales Captivating Packaging
- ★ Excellent Quality
- ★ Full Range Of Models



GALAXY

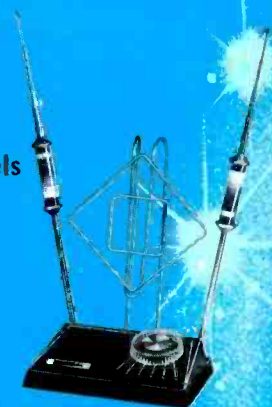

APOLLO

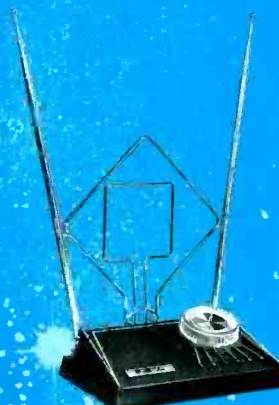

SATURN



VENUS



**GC ELECTRONICS**  
DIVISION OF HYDROMETALS, INC.  
ROCKFORD, ILLINOIS 61101 U.S.A.



For More Details Circle (13) on Reply Card

International ©  
SERVICEMASTER

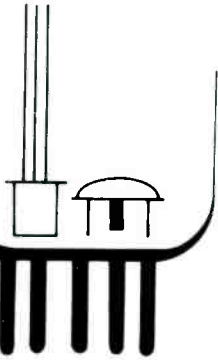

## The Money Making line.

- The most complete range of consumer and industrial receiving tubes in the world — over 2000 domestic and foreign types

- Complete range of replacement Semiconductors.

- Discounted to give you higher profit margins

- Quality your customers can depend on

For complete details, call (516) 293-1500.

Or write,

**International Components Corporation**

105 Maxess Road,  
Melville,  
New York 11746

# test equipment report

These features supplied by the manufacturers are listed at no-charge to them as a service to our readers.

If you want factory bulletins, circle the corresponding number on the Reply Card and mail it to us.

## Master Subber



Castle TV Tuner Service has introduced the Master Subber Mark V, a signal-substitution type of analyzer which furnishes signals for testing all

signal stages of any color or black and white TV receiver. Features include a built-in loudspeaker and video carrier-level meter, a collapsible monopole antenna built into the carrying handle, self-protecting FET/RF stage, and 120 VAC wall plug-in or battery operation. Substitution signals allow tests of stages which include VHF tuner, UHF tuner, each video IF amplifier, video detector, video amplifier, 4.5 MHz sound IF amplifier, sound limiter, sound detector, and audio amplifier.

The Master Subber Mark V measures 6-1/2 X 6-1/2 X 3-1/4 inches and weighs 2-1/2 pounds; it sells for \$169.95.

For More Details Circle (35) on Reply Card

## Mini Test Clip

The "Grabber" Model 4011 test clip is fitted with a gold-plated 6-32 threaded insert and accepts standard scope leads or any lead equipped with a 6-32 screw tip. Available from Pomona Electronics, the "Grabber" features a spring-loaded contact which can be connected securely to component leads or terminals. The 4011 clip is designed for easy attachment by slipping down over .025 square-wire wrap pins or by grabbing the body of the wrap pin for positive contact; the clip is completely insu-



lated to point of connection.

For More Details Circle (36) on Reply Card

## 5-Inch Scope

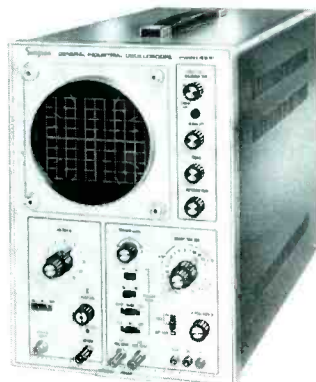

Simpson Electric Company has introduced Model 459, a solid-state,

DC-15 MHz oscilloscope, featuring 5-inch CRT, triggered sweep, and 10 mV/cm vertical sensitivity.

Vertical sensitivity is continuously variable through eleven calibrated steps from 10 mV/cm to 20 V/cm; bandwidth is DC to 15 MHz with a corresponding squarewave response of less than 24 nsec rise time.

Model 459 sells for \$425.00.

For More Details Circle (37) on Reply Card

## Audio Flutter Meter

Model 8160 is a compact, portable meter designed for field service operations. Available from the Mincom Division of 3M Company, the unit complies with IEEE and DIN recom-

SERVICEMASTER  
**International**

For More Details Circle (14) on Reply Card

mended standards for pulse response. The 8160 audio flutter meter sells for \$395.00.

For More Details Circle (38) on Reply Card

### Ground Tester

Model 317 tester is designed to check the ground on 2- or 3-wire outlets, 2- or 3-wire equipment or tools, and 2/3 wire adapters. A total of ten tests can be performed, with 29 different indications for precise troubleshooting.



The 317 ground tester by Butrick Manufacturing Company sells for \$7.95.

For More Details Circle (39) on Reply Card

### Scope Probe

Valor Enterprise, Inc. offers a lightweight probe, designed to give fingertip selection of demodulation, direct, or low-capacity mode of operation for more rapid scope operation. Features include an insulation-piercing prod for quick, positive contact through wire insulation. The shielded signal cable is available with PL-259, BNC, banana plugs, or forked lugs to fit any scope.

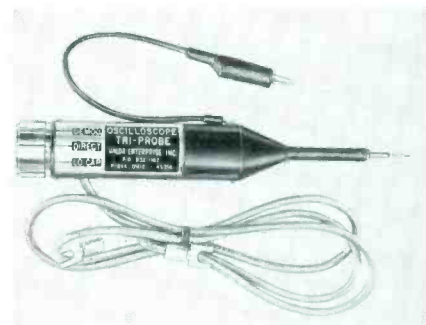

For More Details Circle (40) on Reply Card

**For More Information  
On Items Advertised  
Use Our  
Reader Service Cards**

### Digital Multimeter



Berkeley Instruments, Inc. has introduced Model 4140 4-1/2 digit multimeter. The 4140 is said to operate for long periods of time under wide temperature extremes without reduction of accuracy. Features include precision wire-wound resistors in all critical circuits, sockets for all IC's, and an easy-to-read Sperry display.

Model 4140 multimeter sells for \$495.00.

For More Details Circle (41) on Reply Card

**you'll like this winning combination**

**from Perma Power®**

**A VERY SPECIAL PRICE ON THIS BRITENER SIX-PACK  
AND THE COMBINATION LOCK IS FREE!**



You'll like the six-pack combination: four of the Briteners you use most, Model C-511, plus a Model C-501 and a Model C-212.

You'll like the price: Only \$29.95 for units that would cost \$32.25 purchased individually.

You'll like the free gift: a sturdy combination lock, timed just right for the "back to school" season.

You'll like the results; a happy customer now, when you brighten her faded picture . . . and a probable color tube sale later.

See your Perma Power distributor today, while supplies last.



**Perma Power®**

Chamberlain Manufacturing Corporation  
Perma Power Division  
845 Larch Avenue, Elmhurst, Illinois 60126  
Telephone (312) 279-3600

For More Details Circle (15) on Reply Card

# productreport

These features supplied by the manufacturers are listed at no-charge to them as a service to our readers. If you want factory bulletins, circle the corresponding number on the Reply Card and mail it to us.

## Hand-Held Calculator



The EC-250 portable electronic calculator by **Radio Shack** has auto-constant capability which allows multiplication or division of a long series of numbers without having to re-enter the constant figure. It also

has a full-floating decimal which automatically positions itself correctly, and a clear-entry key which erases only the last number entered without clearing previous entries.

A hooded display allows easy readability of the eight digits even in bright lighting, and an overflow indicator on the panel lights if the answer exceeds eight digits. Three-way power allows operation on AC, rechargeable, or regular penlight batteries. The calculator weighs 8 ounces and measures 5-7/8 X 3 X 1-1/4 inches.

The EC-250 electronic calculator sells for \$69.95, complete with carrying case, AC adapter/charger and instruction booklet.

For More Details Circle (42) on Reply Card

## Film Resistors

The CF series of deposited-carbon film resistors, rated 1/4- and 1/2-watt, are available from **International Components Corporation**.

The resistors meet EIA color coding, dimensional and physical specifications, and are designed for use where carbon composition resistors will not meet performance specifications. They are available in 5% and 2% tolerances, 1 ohm to 1

megohm. Other features include resistance to moisture absorption, a maximum value change on-the-shelf of .15% of resistance, -350 to -650 ppm temperature coefficient, and -25°C to +125° temperature range.

The price of 1000 1/4-watt 5% resistors is \$17.00.

For More Details Circle (43) on Reply Card

## Parts Chest

Inventory can be kept readily visible and accessible in a parts chest by **AMP Special Industries**. Four drawers, each 18 X 12 X 3 inches, slide out to reveal scooped compartments for tools and parts; they can be removed for loading and carrying. Card frames on each drawer allow identification of contents.

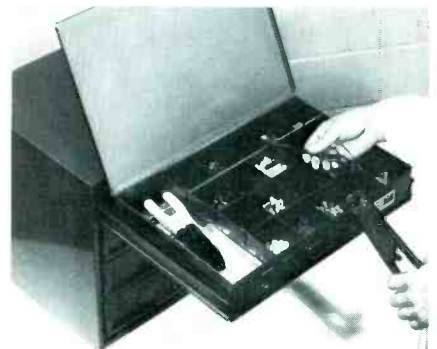

Made of heavy-duty welded steel, the chest measures 20 X 14-1/2 X 15-3/4 inches. Its balanced construction allows extension of a loaded drawer without fear of tipping.

For More Details Circle (44) on Reply Card

## Tube Sockets

Exact replacement Zenith sockets are available from **Oneida Electronic Manufacturing, Inc.** Kit No. 39 contains a general purpose assortment of four sockets, none of which has a substitute. In addition to the kit, Oneida also offers Zenith sockets S-74-C, an exact 9-pin replacement, and S-75-C, an exact 12-pin replacement. The combination of the kit assortment plus the other two sockets provides complete Zenith coverage.

For More Details Circle (45) on Reply Card

## Sound Systems Handbook

A new edition of the "Application Engineered Sound Systems" Handbook is available from the **Bogen Division of Lear Siegler, Inc.** Consisting of a series of specially prepared application and technical sheets in a loose-leaf binder, the 90-page illustrated volume provides informative tips on the selection of amplifiers, loudspeakers, intercoms, and other equipment, plus installation techniques.

The A.E.S.S. Handbook contains numerous examples of the most popu-

# BOTTOMS UP



Start saving the gray bottom flaps with the GE monogram from GE entertainment receiving tube cartons. They're worth valuable awards to independent service dealers and technicians in a fabulous gift bonanza program from General Electric.

The gift list includes some 43 items ranging from sporting equipment to home appliances, from diamond jewelry

to distinctive luggage, from globes and books to calculators and Attend-a-Phones. It even includes the much prized Polaroid SX-70 camera and American Experience weekend vacations at any one of 101 prestigious resorts.

**BOTTOMS UP!!!** Redeem your flaps by November 30, 1974. Full details at your authorized distributor.

TUBE PRODUCTS DEPARTMENT  
GENERAL ELECTRIC COMPANY  
OWENSBORO, KENTUCKY 42301

GENERAL  ELECTRIC

lar types of sound system installations, with particular recommendations for providing optimum sound quality by the use of expertly matched components. The Handbook sells for \$3.95.

For More Details Circle (46) on Reply Card

### Soldering Iron

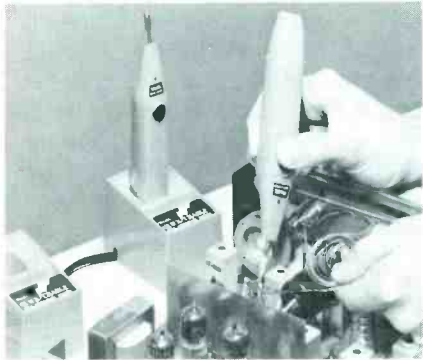

The "Quick Charge" Iso-Tip soldering iron from **Wahl** is now cordless for an even greater percentage of the time. The decrease in recharging time is due to special nickel-cadmium batteries, which are designed for charging at high rates for longer periods of time without deterioration, and for longer life. □

For More Details Circle (47) on Reply Card

## audio systems report

*These features supplied by the manufacturers are listed at no-charge to them as a service to our readers. If you want factory bulletins, circle the corresponding number on the Reply Card and mail it to us.*

### Speaker System

Designed for big sound is the AS-7 three-way speaker system from **Utah Electronics**. The AS-7 features a 12-inch high-compliance woofer driven by an Alnico-V magnet and aluminum voice coil; a mid-range horn-loaded compression driver for wide dispersion of middle frequencies; and a 3-1/2-inch sealed-chassis direct-radiator tweeter.

The AS-7 system measures 14 X 23 X 10 inches, and is rated at 35-18,000 Hz with a peak power capacity of 60 watts and a nominal impedance of 8 ohms. The speaker sells for \$89.95.

For More Details Circle (48) on Reply Card

### Phone-Answering System

**Channel Master** has introduced an automatic telephone-answering system backed by a one year over-the-counter-exchange guarantee. Model

6000 is designed for business and general use, and it can be set to respond to any number of rings.



Other features include a 60-second recording cycle, built-in condenser mike, automatic level control, and push-button operation. Model 6000 sells for \$129.95.

For More Details Circle (49) on Reply Card

### Noise Filter

The DNF 1200 consumer-model noise-reduction unit gives more than 11 dB of noise reduction on most program sources. The filter utilizes only the minimum bandwidth required to accommodate the program material, eliminating unwanted noise and hiss outside that bandwidth. Because this

**WINEGARD AMPLIFIED PRODUCTS PROVEN IN OVER 1,000,000 INSTALLATIONS.**

**CASE IN POINT: WINEGARD SOLID-STATE BOOSTER-COUPPLERS.**



For quality and dependability in booster-couplers, look to Winegard. You know they're good. Because our solid-state, booster-couplers deliver the best TV/FM reception and the best reliability in the industry today. Winegard booster-couplers come in a wide choice of models so each TV system can be "customized" for perfect reception. You can

amplify signals for up to four TV receivers or outlets.

- 75 and 300 ohm models
- 2 to 4 set capability
- solid-state circuitry
- lightning protection diode
- three wire ground cord
- rugged commercial quality steel cabinet

*Best TV products for Best TV reception*

**WINEGARD**  
TELEVISION SYSTEMS

Winegard Company • 3000 Kirkwood Street • Burlington, Iowa 52601

For More Details Circle (16) on Reply Card

# DOTHATCH®

*an exclusive Lectrotech development*

*one new pattern for all coverage adjustments*

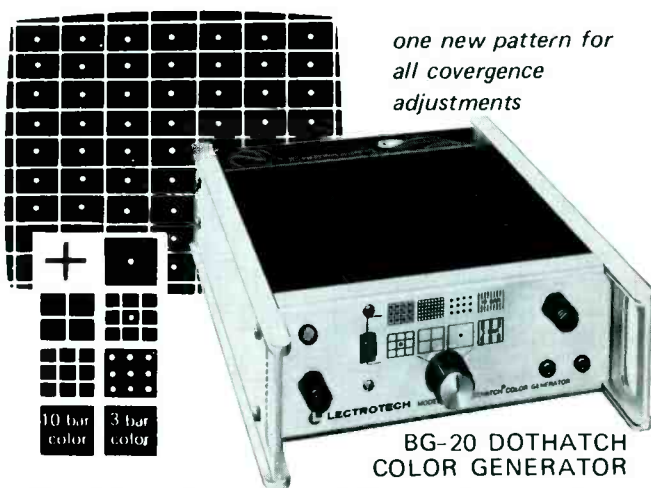

**BG-20 DOTHATCH COLOR GENERATOR**

The ultimate in pattern stability, at all temperatures, provided by Digital IC Counters. No internal adjustments. RF output channel 3 or 4 Video output 3v. P-P. 4.5 MHz crystal sound carrier. With shoulder strap and self-contained cable compartment. Net **129.50**



See your distributor or write

**LECTROTECH, INC.**

5810 N. Western Ave.,  
Chicago, Illinois 60659  
(312) 769-6262



Available in Canada from  
**Superior Electronics Inc.**

For More Details Circle (17) on Reply Card

(Continued from previous page)

is not a pre-encoding technique, all types of program material can be improved, including 78's, LP's, 45's, broadcast, FM, AM, and TV audio.

The unit can easily be connected to the tape record and tape monitor jacks of any high fidelity, stereo or quadraphonic system. It has two light-emitting diode indicators showing the operation of the filter; a single control adjusts the threshold of operation. Available from **Burwen Laboratories**, the DNF 1200 sells for \$249.95.

For More Details Circle (50) on Reply Card

### Four-Channel Headphones

Model TEL-101F four-channel headphones from **Telephonics** utilize the Fixler Effect patents to produce a true and discrete four-channel listening experience.



Each phone contains two high-velocity, wide-frequency-range dynamic drivers, acoustically placed and phased. The sound-coupling system uses open cell urethane foam. The TEL-101F headphones are compatible with all standard amplifier headphone jack impedances. They weigh 20 ounces and have a frequency range of 20 Hz to 20 KHz.

Model TEL-101F four-channel headphones sell for \$75.00.

For More Details Circle (51) on Reply Card

### Telephone "Speakerphone"

**Ford Industries, Inc.** has introduced a new Speakerphone, giving improved sound quality and "hands free" telephone operation. Designed for installation on any telephone line, with standard telephones, or with key sets, the Speakerphone allows users to talk on the telephone without using the regular handset. It permits normal two-way conversations as well as group conversations or conferences.

For More Details Circle (52) on Reply Card

### FREE ALARM CATALOG

Full line of professional burglar and fire alarm systems and supplies. 80 pages, 400 items. Off-the shelf delivery, quantity prices.

 **mountain west alarm**  
4215 n. 16th st., phoenix, az. 85016

For More Details Circle (18) on Reply Card

# catalogs literature

Circle appropriate  
number on Reader  
Service Card.

**100. Brookstone Company**—offers its second 1974 catalog of hard-to-find tools. The 60-page catalog features 76 new products in addition to the thousands of other items available from the firm.

**101. Channel Master**—has released a consumer-products catalog entitled "Channel Master '74—The Natural Sound." The 64-page color catalog features radios, clock radios, cassette player/recorders, modular stereo systems, 8-track equipment, auto entertainers, and portable TV sets.

**102. Fordham Radio Supply**—has announced a 32-page, illustrated discount mail-order catalog. Designed as a quick reference ordering guide for use by radio and TV technicians, electronic technicians, and hobbyists, the catalog includes tools, service and repair kits, tubes, test equipment, phono cartridges and needles, speakers and microphones, antennas, and components.

**103. GTE Sylvania**—offers a catalog describing its line of Pathmaker cable communications equipment. The 41-page catalog features Sylvania series 2000 Trunk Amplifier stations and describes the variety of transmission services that can be obtained with the equipment; transportation/distribution amplifier stations, plug-in modules, power supplies, passive devices and accessories are also described.

**104. International Rectifier Corp.**—makes available a handy, pocket-sized universal-replacement transistor crossover chart, which lists over 250 IR and competitive part numbers. The 8-1/2 X 3-1/2 inch card allows the user to quickly select the proper IR universal transistor to replace universal transistors made by other major suppliers, including Sylvania, RCA, GE, and Motorola.

**105. Nortronics Company**—has introduced a ten-page, two-color brochure describing their line of Re-

order Care Kits. Included are ToteKits 1, 2, and 3 for cassette, 8-track cartridge, and reel-to-reel recorders and players, respectively; Inspection and Cleaning Kits QM-6, 7, 8, and 9 for all machine types; and QM-5 Video Recorder Care Kit for video tape recorders.

**106. Perma Power**—has released a six-page, illustrated catalog of solid-state public-address sound systems. The catalog describes the complete line of Ampli-Vox equipment, covering almost all applications for portable sound systems. A comprehensive range of accessory items are also included.

**107. Projector Recorder Belt Corp.**—offers a catalog listing over 1800 belts available from stock for tape recorders, projectors, record players, dictating machines, and video recorders. A simplified cross-reference system combined with a special belt sizer makes ordering easy and reduces inventory for service and repair shops.

**108. RCA Parts and Accessories**—makes available a 16-page catalog of servicing aids for electronic technicians, featuring the RCA Industry-Compatible Test Jig Program. The manual includes seven pages of photos to help identify the cables and adapters utilized with the test jig, as well as a comprehensive cross-reference chart. Descriptions of other RCA products and accessories are also listed.

**109. Simpson Electric Company**—has released a 108-page Master Catalog containing comprehensive technical information on panel meters, meter relays, controllers, recorders, digital instruments, and test equipment. In loose-leaf form, the catalog is bound in a durable, hard cover, 3-ring binder for easy data change.

**110. Tab Books**—offers its 1974 catalog, describing over 300 current and forthcoming books, plus 14 Electronic Book/Kits. Subject areas include basic electronics technology, CATV and MATV, medical electronics, radio receiver servicing, television servicing, test equipment, communications and CB radio, and transistors and semiconductors.

# antenna systems report

These features supplied by the manufacturers are listed at no-charge to them as a service to our readers. If you want factory bulletins, circle the corresponding number on the Reply Card and mail it to us.

## MATV Head Ends

**Jerrold Electronics Corp.** has introduced complete, factory-assembled, custom MATV head ends, which consist of a Jerrold Channel Commander II signal processor or modulator for each channel to be carried over the system. The Channel Commanders are rack or cabinet mounted and pre-wired, with all necessary mixing.

Each piece of equipment is tested individually for compliance with video specifications including frequency response, sync compression, noise performance and color capability; the entire head is then checked for proper carrier levels and overall capability on a maximum of 30 channels.

For More Details Circle (53) on Reply Card

## Cable Loss Equalizer

A VHF cable loss equalizer which compensates for tilt loss characteristics over a frequency range of 10 MHz through 225 MHz is offered by **Q-Bit Corporation**.

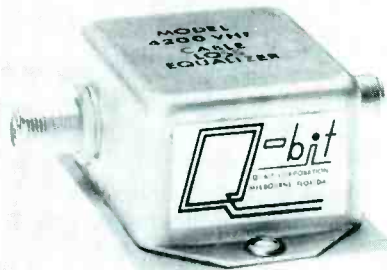

Model 4200 helps reduce the cost of MATV and CATV installations by performing the functions of an amplifier and tilt control, typically required for line compensation. The passive unit compensates a 6 dB tilt factor between channels 2 and 13, correcting for loss over 200 feet of RG-59, and approximately 300 feet of foam RG-6/U. The 4200 sells for \$4.50.

For More Details Circle (54) on Reply Card

## CB/AM/FM Mobile Antenna

A new 3-way mobile antenna is

available from **The Antenna Specialists Company**. Model M-267 features a new coupler which reduces insertion losses and deterioration of AM and FM broadcast signals. The coupler allows use of the single antenna system for both broadcast receiver and CB transceiver operation without any switching or adjustments. Other features include a low VSWR, a power-rating safety factor of 20X, and a single-length, non-telescoping whip which reduces the possibility of mechanical damage.

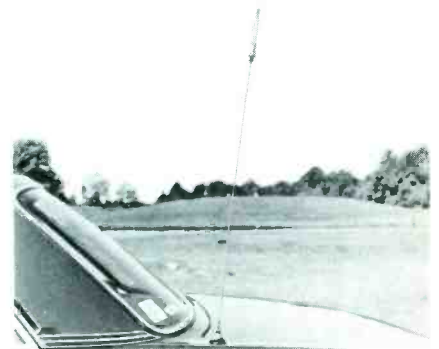

Model M-267 sells for \$35.60, complete with cable and connectors.

For More Details Circle (55) on Reply Card



**COLD**

**COLDER**

**COLDEST**



**NOW AT BETTER DISTRIBUTORS EVERYWHERE**

from **TECH SPRAY** where we find solutions for your problems

# MINI-BAR<sup>®</sup> color generator

\$89.50

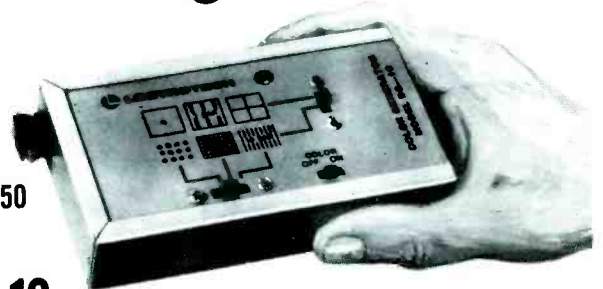

## BG-10 battery-operated, fits in shirt pocket!

No AC plug in . . . automatic on & off with LED indicator . . . fast, easy hook-up with coaxial cable . . . all essential patterns . . . • Low power consumption for extended battery life (Uses inexpensive 9 volt batteries) • Shuts off when not in use • Enclosed RF cable compartment • Size: 5 1/2" x 3" x 1 1/8". Only 12 ounces • TV station type sync signals • CMOS LSI IC for all counting functions . . . no internal adjustments • RF output on Ch. 4 or 5.

BG-10 (less battery) . . . . . \$89.50  
CC-1 Carrying Pouch . . . . . \$ 2.95

See your distributor or write

**LECTROTECH, INC.**  
5810 N. Western Ave.,  
Chicago, Illinois 60659  
(312) 769-6262

Available in Canada from Superior Electronics Inc.

For More Details Circle (19) on Reply Card

September, 1974

For More Details Circle (20) on Reply Card

# servicebulletin

a digest of information from manufacturers

## Reduced HV For Test Tubes RCA CTC64, CTC68 and CTC71 chassis

Operation of the RCA CTC64, CTC68 or CTC71 chassis on test tubes that do not have the high-leaded glass can result in X-radiation in excess of the limits specified by the Federal Government, and in addition might cause arcs or other damage to the picture tube. The following procedures and temporary modification of circuitry reduces the high voltage without disturbing the setting of the HV control.

### CTC64 and CTC68 (Photofact 1378-2)

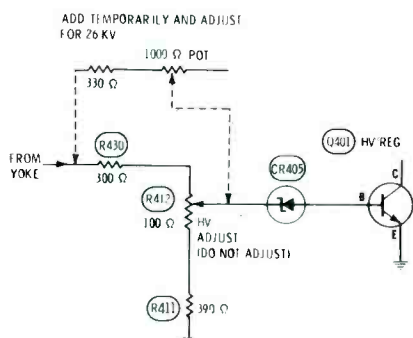

Slide the high-line switch to the "normal" position. Connect a 1,000-ohm pot and a 330-ohm resistor as shown in the diagram. If you are using a 10J275 adapter, connect the yoke to a 10J104 solid-state test jig. This jig uses a CTC40

**FREE CATALOG**

**HARD-TO-FIND PRECISION TOOLS**

Lists more than 2000 items—pliers, tweezers, wire strippers, vacuum systems, relay tools, optical equipment, tool kits and cases. Also includes ten pages of useful "Tool Tips" to aid in tool selection.

**JENSEN TOOLS**

4117 N. 44th Street, Phoenix, Ariz. 85018

For More Details Circle (21) on Reply Card

**OWN YOUR OWN PICTURE TUBE REBUILDING BUSINESS**

With Lakeside Industries rebuilding equipment you can rebuild any picture tube!

For complete details send name, address, zip code to:

**LAKESIDE INDUSTRIES**  
3520 W. Fullerton Ave.  
Chicago, Ill. 60647  
Phone: 312-342-3399



For More Details Circle (22) on Reply Card

yoke, stock 126681. If other jigs are used, install a CTC40 yoke and a 10J275 adapter. Install a 10J274 convergence plug, and connect chassis to the test fixture, except for the socket of the picture tube. Turn on the receiver, and adjust the pot (you have temporarily connected) to obtain 26 KV of high voltage. Do **not** disturb the HV adjust control setting. If the HV cannot be reduced to 26 KV by this method, test the regulator circuit for defects. Connect the picture tube socket and proceed with repairs. Note: the picture will have excessive height and the vertical hold will be at one end for proper locking. If there is a question about vertical performance, install the correct yoke for that model, and don't use the 10J275 yoke adapter. After repairs are completed, remove the temporary pot and resistor, and return the line switch to the original position.

### CTC71 (Photofact 1380-2)

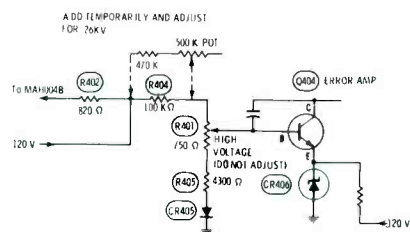

Slide the high-line switch to the "normal" position. Connect a 500K pot and a 470K resistor as shown in the diagram. If you are using a 10J277 adapter, connect the yoke to a 10J104 solid-state test jig. If another jig is used, install a 126681 CTC40 yoke. Connect chassis to the test fixture, except for the socket of the picture tube, and install a 10J274 convergence-jumper plug. Use an isolation transformer to supply power to the chassis, because this is a "hot" chassis. Adjust the temporary pot to obtain 26 KV of high voltage. Do **not** disturb the setting of the HV adjust control. If

the HV cannot be reduced to 26 KV by this method, check the regulator circuit for defects. Connect the picture tube socket and proceed with the troubleshooting. After the repairs are completed, remove the resistor and pot, and restore the line switch to the original setting.

## No raster, or no horizontal locking General Electric SF b-w TV chassis (Photofact 1354-2)

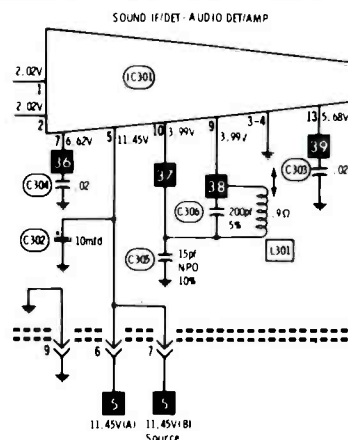

Many different symptoms, such as no raster, intermittent raster, no horizontal locking, intermittent horizontal locking, or poor sound, might be caused by a defect in IC301, the IC on the audio module.

A zener regulator located inside IC301 might reduce the +12 volt supply enough to cause those symptoms.

Measure the DC voltage at the drain of the horizontal oscillator, Q251. Normal voltage should be about +10.5 volts. If it is less than that, replace IC301 (or the audio module in early-production receivers).

Do **NOT** operate the receiver without IC301; and unplug the power cable when IC301, or the module, is out of the receiver. □

### Got A Troubleshooting Tip?

If you've recently run across an unusual trouble symptom, send a thorough description of it and the solution to:

**Troubleshooting Tip,  
Electronic Servicing  
1014 Wyandotte St.  
Kansas City, Mo. 64105**



# bookreview

## Four-Channel Sound

**Author:** Leonard Feldman

**Publisher:** Howard W. Sams & Co., Inc., 4300 West 62nd Street, Indianapolis, Indiana 46268

**Size:** 5-1/2 X 8-1/2 inches, 144 pages

**Price:** \$4.50 softbound

Written with the conviction that four-channel sound, as a home entertainment medium, is here to stay, this book presents a clear picture of how various four-channel systems work, how four-channel sound can improve present sound systems, what to look for in assembling or purchasing a four-channel high-fidelity music system, and what lies ahead for this new form of musical reproduction. Matrix techniques and discrete four-channel discs are discussed at length. Complete chapters are devoted to four-channel FM broadcasting, four-channel sound on tape, discrete records, and matrixing techniques. An appendix is included to acquaint the reader with new terms from the growing field of four-channel sound.

## CET License Handbook

**Author:** Joseph J. Carr

**Publisher:** Tab Books, Blue Ridge Summit, Pennsylvania 17214

**Size:** 5-1/2 X 8-1/2 inches, 276 pages

**Price:** \$8.95 hardbound, \$5.95 softbound

This book is intended as a review for the technician preparing for a Certified Electronic Technician exam (television, audio, or industrial), a state or local license exam, or a job-entry exam. The material is arranged logically for minimum study time and maximum retention. The beginning chapters explain the administration and scope of the CET exams, which are given by the National Electronic Service Dealers Association (NESDA). Topics include a review of simple AC and DC circuits, a minicourse in simple circuit math, explanations of various common circuits such as filters, resonant circuits, and differentiators, and a description of how AM, FM, and TV signals are shaped up and shipped out by modulators and transmitters. Subsequent chapters take the reader through antennas and transmission lines, electronic servicing equipment, the use and application of common circuit components, basic TV theory (including waveform analysis), and troubleshooting. The final chapters prepare the reader to pass the two new CET exams and include a realistic sample test that will serve as a dry run for the actual CET exams.



# 0.1 Hz to 1 MHz for only \$99.95\*

**This new function generator from Heath offers sine, square & triangle waveforms, wide frequency range, 10 V output, 70 dB attenuation for only \$99.95\* kit, \$140\* assembled**

Every service bench needs a good function generator. And now Heath offers a true function generator at a price everyone can afford. Our 1271 provides sine, square or triangle waveforms from 0.1 Hz to 1 MHz with a 10 volt peak-to-peak output into a 50-ohm load. The calibrated attenuator provides 0 to 50 dB attenuation in 10 dB steps with up to 20 dB additional variable attenuation for each step, for a total of 70 dB. Triangle waveform linearity is 5% maximum, with waveform symmetry within 10%. Sine wave harmonic distortion is 3% maximum from 5 Hz to 100 kHz. Square wave rise and fall times are 100 ns max. Its light weight and small size allow it to be placed almost anywhere. The adjustable tilting handle provides easy carrying and positioning for best access to the front panel controls. For \$140\*, you can have the SG-1271, completely factory assembled and calibrated. Or buy the kit-form IG-1271 for only \$99.95\* and save by building it yourself—a triggered scope is all that's needed for alignment.



Our latest catalogs contain complete description & specs for the 1271 and many other high-performance, low cost instrument values from Heath. Send for your free copies and see how you can get more value for your instrument dollar.

**HEATH COMPANY**  
Dept. 196-9  
Benton Harbor, Michigan 49022

HEATH  
**Schlumberger**

Please send the 1975 Heathkit Catalog.

Please send the latest Assembled Instruments Catalog.

Name \_\_\_\_\_

Company/Institution \_\_\_\_\_

Address \_\_\_\_\_

City \_\_\_\_\_ State \_\_\_\_\_ Zip \_\_\_\_\_

\*Mail order prices; F.O.B. factory. Prices & specifications subject to change without notice.

AI-106

# ROHN<sup>®</sup> TOWERS

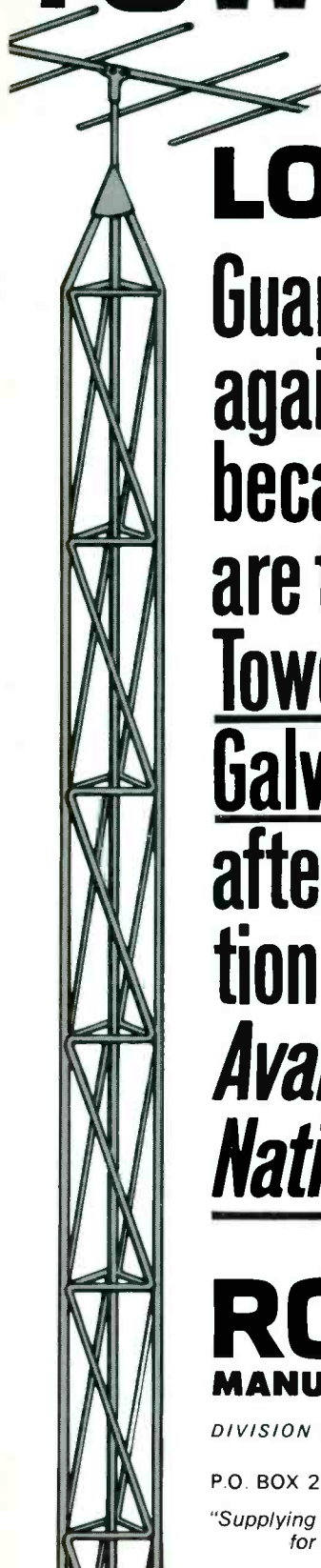

## LAST LONGER

Guaranteed  
against Rust  
because they  
are the *only*  
Tower Hot Dip  
Galvanized  
after fabrica-  
tion and  
*Available*  
*Nationally*

## ROHN<sup>®</sup> MANUFACTURING

DIVISION OF



P.O. BOX 2000 / PEORIA, ILL. 61601

"Supplying tower needs worldwide  
for over 25 years."

## photofact<sup>™</sup>bulletin

PHOTOFACT BULLETIN lists new PHOTOFACT coverage  
issued during the last month for new TV chassis.

<b>HITACHI</b>	
T-21D (Ch. SW).....	1423-1
<b>MGA</b>	
CS-150 .....	1422-1
<b>PANASONIC</b>	
AN-96A, AN-226/A .....	1425-1
<b>PHILCO-FORD</b>	
Chassis 4BI17, 4BI18 .....	1422-2
<b>RCA</b>	
AT121G/T (Ch. KCS190D) .....	1424-1
<b>RCA</b>	
Chassis CTC58N .....	1428-2
<b>SEARS</b>	
363.51750300.....	1421-2
<b>SEARS</b>	
562.51040300, 562.51140300.....	1427-2
<b>SHARP</b>	
C-1228 .....	1424-2
<b>SONY</b>	
KV-9000U (Ch. SCC-BO1-H).....	1425-2
<b>SYLVANIA</b>	
Chassis E04-1, E04-2 .....	1425-3
Remote Control Receiver RC-15, Transmitter 02-37559-1 .....	1425-3-A
<b>TELEDYNE</b>	
2M321BG (Late Production).....	1428-3
<b>TELEDYNE</b>	
3G132 WL .....	1421-3
<b>TOSHIBA</b>	
T221 (Ch. TAT-7015) .....	1422-3
<b>TOSHIBA</b>	
Chassis TAM-4014 .....	1423-2
<b>WARDS AIRLINE</b>	
GAI-12933A/B/C/D/E.....	1424-3
<b>WARDS AIRLINE</b>	
GAI-17833A/33B/33C/43A/43B/43C/ 53A/53B/53C, GAI-17933A/33B/33C/ 43A/43B/43C/53A/53B/53C .....	1427-3
Remote Control Receiver SCR-422R, Transmitter SCR-422T .....	1427-3-A
<b>ZENITH</b>	
Chassis 23EC15 .....	1423-3
Remote Control Receiver S-96247, Transmitter S-94828.....	1423-3-A

## Motorola AGC

(Continued from page 20)

the same as those of the previous case: overload, but normal IF gain. However, very little DC voltage could be measured across C9. Then a scope waveform showed large-amplitude horizontal pulses across C9, a positive proof C9 was open.

Incidentally, several instances of overload when the set was first turned on, followed by normal operation after the set warmed up thoroughly, were traced to C9's that had white powder around the leads. Probably they were partially dried up.

Another time the DC measurements showed no negative voltage across C9, but the scope showed virtually zero amplitude of horizontal pulses at the collector of Q15. A poor solder joint at the cathode of X18 was responsible.

Loss of AGC also can be caused by an open or shorted X18.

### No sound, no picture

Installation of a new "B" panel brought back both sound and picture, but I wanted to know what was bad. First I found there was no +33 volts, although +34 volts was measured at terminal 7 of the panel. After some testing, I found C92 had shorted and burned open L45.

### Weak contrast

When tuned to the strongest signal, only a weak picture could be seen, while off channel there was no snow. Appeared to be an open IF transistor. However, voltmeter checks showed the IF AGC to be high at nearly +5 volts, and the RF AGC also was high at around +22. These are the kind of readings found when the AGC is too active, and little time was required to find Q15 had a collector-to-emitter short.

### Summary

AGC action in the all-solid-state Quasar Motorola color receivers

**For More Information  
On Items Advertised  
Use Our  
Reader Service Cards**

can be tested by the same methods used in other transistorized circuits.

However, you should remember that the tuner, "B" panel, and "E" panel are all part of the AGC circuit. In addition, the white wire between the tuner and the "B" panel can cause some unusual symptoms if it opens or becomes shorted to chassis. □

## Warranty Roundup

(Continued from page 15)

service invoices. However, we discovered that the two items were separated and sent to two different departments, and naturally the service invoices were winning the race into the computer, resulting in automatic disqualification.

In addition, this computer not only has a weak stomach, but it also will not stand for bigamy. When a selling dealer takes back an item from a customer and resells it, the computer is so shocked it spits out any labor claims for the new owner.

One solution is to have the selling dealer register the sets through you, or give you the information so you can register and keep a record of them. But if such close cooperation is not possible, obtain blank registration forms and send in a completed one before you perform the initial service. Caution! The set must be registered some time before the labor claim is submitted, and don't forget to submit the claim within the 30-day time limit. Sometimes that makes for a tight squeeze.

### Other warranty sins

Other minor infractions can result in rejects of your labor claims. Some of these are "Incorrect part number", "Wrong number of digits in the serial number", "Need chassis (or registration) number", and many more.

### Summary

Although it might seem otherwise, this article is not intended to discourage you from taking the plunge into warranty service, but it is an attempt to aid and prepare you for the pitfalls.

Warranty service is a challenge, and part of the satisfaction comes when you receive invoices marked

"Paid" rather than "Rejected." Then you will know you have done something right, even in the critical eyes of the manufacturer and the judgement of the cold computers.

All the examples given here don't apply to all manufacturers, but at least some of them apply to most. My one fear in writing this article is that some representative of a manufacturer might read it and discover a new excuse for rejecting labor claims. So I will conclude by saying, "We have had enough already." □

# need belts?



**THESE 5 LITTLE BOXES  
PROVIDE 75% OF YOUR  
INVENTORY NEEDS!**

Drive Belts and Wheels for over 1900 makes and models of tape recorders, dictating machines, projectors, video recorders . . . Eliminate over-stocking of interchangeable belts. Eliminate costly stock mix-ups. Use the unique, simplified PRB cross-reference system and belt-sizer. You can reduce 75% of your belt stock to five little boxes. All belt kits (drive tires, and phono idlers, too) are ready for same-day shipment on orders of one or two . . . or the full set!

SPECIAL OFFER . . . Free sample cassette belt of your choice (send old belt and make and model information). FREE catalog/cross-reference chart included. Write or call today.

**PROJECTOR RECORDER  
BELT CORPORATION**

310 Whitewater St., Whitewater, Wis.  
53190 414/473-2151

For More Details Circle (26) on Reply Card

# The MARKETPLACE

This classified section is available to electronic technicians and owners or managers of service shops who have for sale surplus supplies and equipment or who are seeking employment or recruiting employees.

### Advertising Rates

in the Classified Section are:

- 25 cents per word (minimum \$3.00)

- "Blind" ads \$2.00 additional

- All letters capitalized 35 cents per word

Each ad insertion must be accompanied by a check for the full cost of the ad.

Deadline for acceptance is 30 days prior to the date of the issue in which the ad is to be published.

This classified section is not open to the regular paid product advertising of manufacturers.

## FOR SALE

USE YOUR SCOPE (ANY MODEL, NO REWIRING) TO TEST TRANSISTOR IN/OUT CIRCUIT. SIMPLE INSTRUCTIONS \$1.00. SCHEK TECHNICAL SERVICES, 8101 SCHRIDER ST., SILVER SPRING, MARYLAND 20910. 10-73-12

UNUSUAL SURPLUS AND PARTS Catalog. \$1. ETCO Electronics Dept. E.S., Box 741, Montreal "A" H3C 2V2 12-73-121

NOW LIQUIDATING items below, purchased new during past six months for planned shop which now cannot open. Must be liquidated quickly, priced accordingly. All guaranteed perfect, inspection appointments welcome. Exceptional deal available on entire package, but offers welcome on separate lots and items as noted. **EQUIPMENT:** Offers welcome on items or lot. Top of line solid state, mint condition, most never used. Prices 30% below today's manufacturers' list. **B & K MODELS:** 501A curve tracer; 801 capacitor analyst; 970 transistor equipment analyst; 415 sweep/marker generator; 2902 sub box; HV32 probe; 1077B television analyst. **SENCORE MODELS:** FE160 senior FET meter; CR168 CRT checker; PM157 power monitor; SG165 AM-FM stereo analyzer; CG169 color bar generator; SS137 sweep circuit analyst; TF26 Cricket transistor checker; PS163 dual trace triggered solid state scope; MU150 mu tube checker. **EICO MODELS:** 635 tube checker; 1140 sub box; 955 capacitor checker; 1030 power supply. **SAMS PHOTOFACTS & MANUALS:** 675 photofacts (250 popular sets between 1 and 984; plus 425 consecutive sets from 984 to 1409 current). New, perfect condition, in folders, referenced, updated, in two new four drawer steel cabinets. Also 100 TSM's and AR's; and over 30 special Sams books. Conservatively valued over \$2500; want \$1500 or best offer, one lot only. **TUBES & PARTS:** 320 top brand, current "most popular" tubes. Value at dealer cost about \$500; want \$275, entire lot only. New miscellaneous TV parts valued about \$400, want \$125 for all, entire lot only. J. Clark, 16390 W. 44th Ave., #12, Golden, Colorado 80401. Phone AC 303-279-4701 weekends. 9-74-11

## FOR SALE (CONT'D)

**T.V. EQUIPMENT & PARTS:** Complete line of testing equipment and parts inventory to exceed \$4,000 cost value. Buy for \$1,500. Call or write, Lutton's True Value Hardware, P.O. Box 52, Drain, Oregon 97435, 1-503-836-2231. 9-74-11

**DYNACO-A-R \*TRANSISTORS \*REPAIRS - BOARDS & UNITS \*SPEAKER SERVICE \*\*SEND FOR PRICES & DETAILS. BEAR ELECTRONICS, 177 HILLCREST ROAD, MT. VERNON, N.Y. 10552. 9-74-11**

**QUARTZ CRYSTALS, COLOR TV BURST OSCILLATOR.** Admiral, Magnavox, RCA, Sylvania, Zenith and other receivers. Aluminum holder, wire leads. Fifty pieces \$1.39 ea. One hundred \$1.32 ea. Immediate delivery, cash only. Scientific Crystal, 228 York Road, Carlisle, Pa. 17013. AC 717-249-6091. 9-74-11

## WANTED

**WANTED—ELECTRONIC TECHNICIAN, UNUSUAL OPPORTUNITY FOR ONE WELL QUALIFIED IN COLOR TV. TOP SALES AND SERVICE SHOP HAS 40 YEAR REPUTATION. WE MUST REPLACE RETIRING PARTNERS. MUST BE HONEST, EAGER TO LEARN, AND ENJOY SERVING PEOPLE. CONTACT: WELLS & LATHTE, VICKSBURG, MS. 39180. 8-74-31**

**WANTED—The following FM test equipment or equivalent: Lamkin 205A modulation meter. Measurements 80 signal generator. Gertsch FM-6 frequency meter. Horace Gooding, 208 Sonset Drive, Williamston, N.C. 27892. 9-74-11**

## EDUCATION-INSTRUCTION

**REPAIR TV TUNERS—High Earnings; Complete Course Details, 12 Repair Tricks, Many Plans, Two Lessons, all for \$2. Refundable. Frank Bocek, Box 3236 Enterprise, Redding, Calif. 96001. 6-74-61**

**NOW! Master Solid State Vertical Oscillator-Output Circuit problems. Latest instruction teaches current circuitry. \$1 brings lesson, details. Reidel, Box 9603, Denver, Colorado 80209. 7-74-11**

## advertisers' index

B & K Div., Dynascan Corp. ....	7
Bussmann Mfg. Div. ....	
McGraw-Edison .....	21
Castle TV Tuner Service, Inc. ....	Cover 4
Channel Master .....	1
Chemtronics Incorporated .....	35
The Finney Company .....	30
Fluke Mfg. Company .....	43
GC Electronics .....	43
Gem City Tuner .....	10
General Electric Company .....	46
Heath Company .....	51
International Components Corp. ....	44
Jensen Tools and Alloys .....	50
Jerrold Electronics .....	Cover 3
Lakeside Industries .....	50
Lectrotech, Inc. ....	47, 49

Mountain West Alarm Supply Co. ....	48
Perma Power Company .....	45
Pomona Electronics .....	9
Precision Tuner Service .....	Cover 2
Projector-Recorder Belt Co. ....	53
Rohn Manufacturing .....	52
Sprague Products Company .....	11
GTE Sylvania - Consumer Renewal .....	19, 31
Tech Spray .....	49
Tektronix, Inc. ....	3
Tuner Service Corporation .....	5
Winegard Company .....	27, 47

# Help college help you.

Businesses like yours gave over \$340,000,000 to higher education last year.

It was good business to do so. Half of all college graduates who seek work go into business. The more graduates there are, and the better educated they are, the more college serves the business community.

Your money was vital to colleges. It relieved financial pressures, made planning more flexible, and contributed to the kind of basic and applied research that puts new knowledge and technology at the service of industry.

So that colleges can continue to help you, give to the college of your choice now. For information on ways to do it, please write on your letterhead to Council for Financial Aid to Education, Inc., 6 East 45th Street, New York, N.Y. 10017. Ask for the free booklet, "How Corporations Can Aid Colleges and Universities."

# Look up to Jerrold's new line of TOWERS

*a complete line of towers for  
MATV & Home TV/FM Antennas that are  
stronger, easier to put up and last longer.*

Of course, these are not ordinary towers. For more than a quarter of a century, Jerrold has developed and produced the finest equipment for MATV and home antenna TV systems. Our towers are proven designs of the same high quality.

There are actually three complete lines of Jerrold towers.

**The QDMX series are self-supporting concrete-base towers**, 28 to 68 feet high. QDMX towers use heavier steel (12 to 16 gauge vs. 14 to 18 gauge) and a heavier mast than competitive towers. They are wider at the bottom, tapering gracefully to the top.

**The QDME series are bracketed towers**, ranging from 20 to 52 feet high. Construction is of straight sections similar to that of the QDMX series.

**Golden Nugget series towers** are the finest tubular steel bracketed towers available, and they are popularly priced. Unique "Golden Nugget" welds are extremely strong and will never rust. Whereas competitive tubular towers use 18 gauge legs, Golden Nuggets use 16 gauge legs for extra strength. Golden Nuggets are available in 10-foot sections. Jerrold also offers a full line of slip-up masts and tripods.

Jerrold towers are priced competitively, but impossible to match in value. For more information, contact your local Jerrold Distributor.

 **JERROLD**  
a GENERAL INSTRUMENT company

**JERROLD ELECTRONICS CORPORATION**  
**Distributor Sales Division**

P.O. Box 350

200 Witmer Road, Horsham, Pa. 19044

For More Details Circle (2) on Reply Card

# SUBBER™

## TV Service Instruments for signal circuit analyzing.

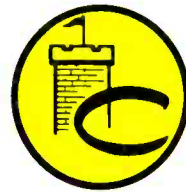

When Castle introduced the TV Tuner SUBBER\* analyzing instrument a couple of years ago it became the first practical way to easily test the VHF tuner, UHF tuner and i.f. amplifier system of any TV receiver. Being lightweight, self contained and battery powered the TV Tuner SUBBER\* Mk. IV is the first such instrument which may be carried on service calls and used with ANY color or black and white TV receiver . . . at \$45.95 for the battery powered Mk. IV, or \$54.95 for the a.c. plus battery powered Mk. IV-A the instruments have been known to pay for themselves in **TIMESAVING** in the first two weeks of use!

Now we have introduced the Mk. V Master SUBBER\*, an instrument which is absolutely unique . . . there is nothing else like it anywhere! It is completely portable and battery powered, practically foolproof in it's simplicity of operation when testing ALL the signal stages of any color or black and white TV receiver. The substitution signals available allow tests of the following stages: VHF tuner, UHF tuner, each video i.f. amplifier, video detectors, video amplifiers, 4.5 MHz sound i.f. amplifiers, sound limiter, sound detector and audio amplifier. It includes a signal level meter for testing the antenna signal. Inbuilt telescopic antenna makes the meter adaptable for true field strength measurements. Inbuilt monitor loudspeaker ensures foolproof substitution tests . . . every time!

At \$169.95 the Master SUBBER\* instrument is the best bargain in an analyzer that has ever been available. It will save oodles of time in the hands of a professional troubleshooter . . . and help advance the novice to professional status.

All SUBBER\* instruments come complete with batteries, connecting cables and comprehensive instruction manual. The Master SUBBER\* and Mk. IV-A TV Tuner SUBBER\* come complete with wall plug-in transformer for 120vac 60 Hz operation.

As an added bonus, all SUBBER\* instruments enable use of the high speed agc system analyzing procedure invented by Castle . . . the first practical method for analyzing agc system defects without confusion.

\*A trademark of Castle TV Tuner Service, Inc.



These instruments boast the extra features of all Castle products — advanced technology — modern styling — and they work!

If you need to save some analyzing time . . . you need a SUBBER\* instrument!

See your stocking distributor . . . or write for more details and complete specifications.

**CASTLE TV TUNER SERVICE, INC.**

5701 N. Western Ave., Chicago, Illinois 60645 Phone: (312) 561-6354

In Canada: Len Finkler Ltd., Ontario

For More Details Circle (3) on Reply Card

www.americanradiohistory.com